

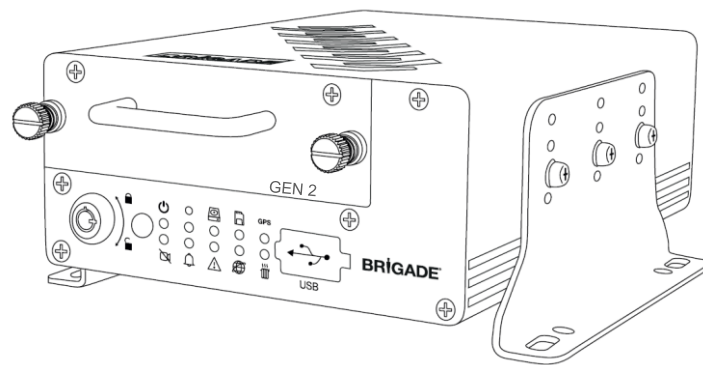

Mobile Digital Recorder

MDR-504XX-X-XX-XXX(XX)



MDR-508XX-X-XX-XXX(XX)

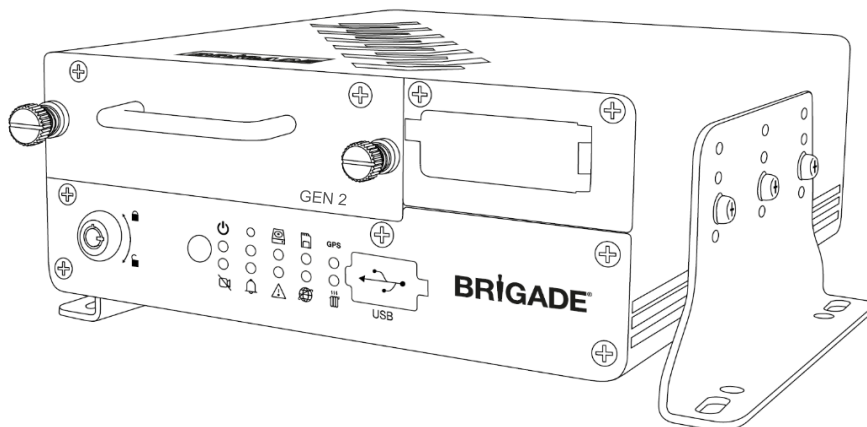

MDR 500 Series Installation and Operation Guide

Please refer to www.brigade-electronics.com for the latest version of this manual

Table of Contents

1	Introduction to MDR 500 Series Technology	3	8.2	Modules	40
1.1	Product Features	4	8.2.1	Mobile Network	40
1.1.1	Differences between MDR-504XX-X-XX-XXX(XX) and MDR-508XX-X-XX-XXX(XX)	4	8.2.2	Wi-Fi	40
1.1.2	Common to MDR-504XX-X-XX-XXX(XX) and MDR-508XX-X-XX-XXX(XX)	4	8.2.3	GPS	41
2	Kit Contents	4	8.3	Server Status	41
2.1	MDR-504XX-X-XX-XXX(XX) and MDR-508XX-X-XX-XXX(XX) Kits	4	8.4	Environment	41
2.1.1	MDR-504XX-X-XX-XXX(XX)	4	8.5	Storage	41
2.1.2	MDR-508XX-X-XX-XXX(XX)	5	8.6	History	42
2.1.3	Common for MDR-504XX-X-XX-XXX(XX) and MDR-508XX-X-XX-XXX(XX)	5	9	MDR-Dashboard 5.0	42
2.2	Optional Accessories	5	9.1	PC System Requirements	42
2.2.1	Remote Status & Interface Panel	5	9.2	Retrieving HDD Data (Quick Guide)	42
2.2.2	External G-Sensor	6	9.3	Installing MDR-Dashboard 5.0	43
2.2.3	SD Cards	6	9.4	Connecting the MCU to the PC	44
2.2.4	Fireproof Box with 32GB SD Card	6	9.4.1	Pre-Connection Procedure (Preferred)	44
3	Hardware Installation	6	9.4.2	MCU Connection Procedure (Required)	44
3.1	Front View	6	9.4.3	Connection Confirmation	44
3.1.1	MDR-504XX-X-XX-XXX(XX) Front View	6	9.5	Loading from HDD/SD	44
3.1.2	MDR-508XX-X-XX-XXX(XX) Front View	7	9.6	MDR-Dashboard 5.0 Local Mode	45
3.2	Rear View	7	9.6.1	Channel Info	46
3.2.1	MDR-504XX-X-XX-XXX(XX) Rear View	7	9.6.2	Events and Graphs	46
3.2.2	MDR-508XX-X-XX-XXX(XX) Rear View	8	9.6.3	Frame Information	48
3.3	Mobile Caddy Unit (MCU Contains HDD)	8	9.6.4	Sensor Status	48
3.3.1	MDR-500-X-MCU-XX-XXX	8	9.6.5	Map Tracking	48
3.4	USB Mouse / Remote Control (Optional)	8	9.7	Loading from a USB flash drive or Folder	48
3.5	MDR-504XX-X-XX-XXX(XX) Connection Diagram	9	9.8	Reading Data	50
3.6	MDR-508XX-X-XX-XXX(XX) Connection Diagram	10	9.9	Exporting Videos	51
3.7	Mobile Caddy Unit Removal	11	9.10	Saving Snapshots	52
3.7.1	MDR-504XX-X-XX-XXX(XX) MCU Removal	11	9.11	User and System settings	52
3.7.2	MDR-508XX-X-XX-XXX(XX) MCU Removal	11	10	MDR-Player 5.0	54
3.8	SD Card Removal	12	10.1	Exported MDR-Player 5.0	54
3.8.1	MDR-504XX-X-XX-XXX(XX) SD Card Removal	12	10.2	Setting up MDR-Player 5.0	54
3.8.2	MDR-508XX-X-XX-XXX(XX) SD Card Removal	12	10.3	Basic Operations	54
3.9	SIM Card Installation	12	11	Advanced Ethernet Configurations	57
3.9.1	MDR-504XX-X-XX-XXX(XX) SIM card Installation	12	11.1	Ethernet Setup	57
3.9.2	MDR-508XX-X-XX-XXX(XX) SIM card Installation/Expansion Module Upgrade	13	11.2	Ethernet Operation	58
3.10	Antennae Installation	13	11.3	Ethernet Maintenance	59
3.10.1	GPS antenna Installation (Included)	13	11.4	Ethernet Log	60
3.10.2	Wi-Fi antenna (Depending on Model)	13	11.5	Ethernet Configuration	60
3.10.3	Mobile Network antenna (Depending on Model)	13	12	On-screen Display Map	61
4	MDR On-Screen Display (OSD)	14	12.1	Rec Search	61
4.1	Quick Menu	14	12.1.1	Rec Search	61
4.2	Login	15	12.2	SYSTEM INFO	62
4.3	Logout	16	12.2.1	Version Info	62
5	Record Search	16	12.2.2	Modules	63
6	Log Search	17	12.2.3	Server Status	64
7	Setup	18	12.2.4	Environment	64
7.1	Basic Setup	18	12.2.5	Storage	64
7.1.1	Register Information	18	12.2.6	History	64
7.1.2	Time Setup	19	12.3	LOG SEARCH	65
7.1.3	Power	19	12.4	SETUP	65
7.1.4	User Setup	21	12.4.1	Basic Setup	65
7.1.5	HDD Key	21	12.4.2	Surveillance	70
7.1.6	Network	22	12.4.3	Events	74
7.1.7	Application	25	12.4.4	Alarms	77
7.2	Surveillance	25	12.4.5	Maintenance	85
7.2.1	Live View	25	12.5	LOGOUT	87
7.2.2	Record	26	12.5.1	Logout Prompt	87
7.2.3	IP Camera Setup	29	13	Help Button	88
7.3	Events	29	14	Mounting Dimensions	90
7.3.1	General	29	14.1	MDR-504XX-X-XX-XXX(XX)	90
7.3.2	Snapshots	30	14.2	MDR-508XX-X-XX-XXX(XX)	90
7.4	Alarms	31	15	Appendices	90
7.4.1	General	31	15.1	Video Quality Table	90
7.4.2	Video	33	15.2	Normal / Alarm Recording Parameters	91
7.4.3	Advanced	34	15.3	Sub-Stream Recording Parameters	91
7.5	Maintenance	35	15.4	User Log Description	92
7.5.1	Configuration	35	15.5	MDR-Dashboard 5.0 Silent Installation	92
7.5.2	Metadata	37	15.6	MDR-Dashboard 5.0 Additional PowerShell Switches	92
7.5.3	Upgrade	37	15.7	Events Table	93
7.5.4	Storage	38	16	Testing and Maintenance	93
7.5.5	Reset	38	16.1	Operator Instructions	93
7.5.6	Hardware	38	16.2	Maintenance and Testing	94
7.5.7	Certificate	39	17	General Antennae Guidelines	94
8	System Information	40	18	Troubleshooting	95
8.1	Version Information	40	18.1	MDR Unit	95
			18.2	MDR Fireproof Box	95
			19	Specifications	96
			20	EU Declaration of Conformity	99
			21	Glossary	100
			22	Disclaimer	101

1 Introduction to MDR 500 Series Technology

Brigade's MDR-508XX-X-XX-XXX(XX) and MDR-504XX-X-XX-XXX(XX) are advanced Mobile Digital Recorders (MDRs) designed to record and playback 8 or 4 channels. The system uses Analog High Definition (AHD), Phase Alternating Line (PAL) or National Television System Committee (NTSC) television systems. The resolution can be CIF, WCIF, HD1, WHD1, D1, WD1 or AHD. Information related to recording parameters, alarms and trigger status can be recorded along with speed, location and G-Force data. In addition, data related to the unit itself such as voltage and temperature are recorded and plotted graphically in MDR Software (MDR-Dashboard 5.0 and MDR-Player 5.0). This information is called metadata.

Recordings can be searched, viewed and exported (clipped and saved locally) using MDR-Dashboard 5.0 software. This allows users to access all the vehicle's travel information, including route tracking. Recordings can be easily exported in three different ways: as a simple audio/video MP4 file playable by consumer media players; as native proprietary format clips or as a password protected .exe file with an embedded MDR-Player 5.0.

The main storage unit is a large capacity Hard Disk Drive (HDD) or Solid-State Drive (SSD). The secondary storage is an internal SD (Secure Digital) card for sub-stream, HDD mirror (simultaneous) or alarm recording. The SD card stores video data and frame information only in chosen image resolution and frame rate. This is useful in extreme scenarios where the primary storage media reaches its limitations (e.g. an HDD/SSD write error during a collision).

Mobile network and Wi-Fi settings found in this manual relate to wireless products as described below. These features can be attained by upgrading the MDR 500 Series units. 8 channel models allow users to modularly upgrade. These units can be upgraded by various expansion modules. 4 channel units do not have a modular design to allow for mobile network/Wi-Fi upgrades.

To complete firmware upgrades, configuration imports/exports and video exports a bus-powered hub (minimum 2 ports) is required.

It is imperative that Brigade MDRs are fitted and commissioned by competent and trained technicians. The installers are responsible for the correct setup of the overall system and must adhere to relevant regulations and legislation.

Table 1: Description of MDR 500 Series Models:

#	MODEL	NUMBER OF CHANNELS	HDD CAPACITY	SD CAPACITY	GPS	MOB. NET	WI-FI
(1)	MDR-504-1-G2-CMR	4 (Analogue) + 2 (IP)	1TB	32GB	✓		
(2)	MDR-504G-1-G2-CMR	4 (Analogue) + 2 (IP)	1TB	32GB	✓	✓	
(3)	MDR-504GW-1-G2-CMR	4 (Analogue) + 2 (IP)	1TB	32GB	✓	✓	✓
(4)	MDR-504G-1-G2-CMR(NA)	4 (Analogue) + 2 (IP)	1TB	32GB	✓	✓	
(5)	MDR-504GW-1-G2-CMR(NA)	4 (Analogue) + 2 (IP)	1TB	32GB	✓	✓	✓
(6)	MDR-504-0.5-G2-SSD	4 (Analogue) + 2 (IP)	500GB	32GB	✓		
(7)	MDR-504G-0.5-G2-SSD	4 (Analogue) + 2 (IP)	500GB	32GB	✓	✓	
(8)	MDR-504GW-0.5-G2-SSD	4 (Analogue) + 2 (IP)	500GB	32GB	✓	✓	✓
(9)	MDR-504G-0.5-G2-SSD(NA)	4 (Analogue) + 2 (IP)	500GB	32GB	✓	✓	
(10)	MDR-504GW-0.5-G2-SSD(NA)	4 (Analogue) + 2 (IP)	500GB	32GB	✓	✓	✓
(11)	MDR-504-1-G2-SSD	4 (Analogue) + 2 (IP)	1TB	32GB	✓		
(12)	MDR-504G-1-G2-SSD	4 (Analogue) + 2 (IP)	1TB	32GB	✓	✓	
(13)	MDR-504GW-1-G2-SSD	4 (Analogue) + 2 (IP)	1TB	32GB	✓	✓	✓
(14)	MDR-504G-1-G2-SSD(NA)	4 (Analogue) + 2 (IP)	1TB	32GB	✓	✓	
(15)	MDR-504GW-1-G2-SSD(NA)	4 (Analogue) + 2 (IP)	1TB	32GB	✓	✓	✓
(16)	MDR-504-2-G2-SSD	4 (Analogue) + 2 (IP)	2TB	32GB	✓		
(17)	MDR-504G-2-G2-SSD	4 (Analogue) + 2 (IP)	2TB	32GB	✓	✓	
(18)	MDR-504GW-2-G2-SSD	4 (Analogue) + 2 (IP)	2TB	32GB	✓	✓	✓
(19)	MDR-504G-2-G2-SSD(NA)	4 (Analogue) + 2 (IP)	2TB	32GB	✓	✓	
(20)	MDR-504GW-2-G2-SSD(NA)	4 (Analogue) + 2 (IP)	2TB	32GB	✓	✓	✓
(21)	MDR-508-1-G2-CMR	8 (Analogue) + 8 (IP)	1TB	64GB	✓		
(22)	MDR-508G-1-G2-CMR	8 (Analogue) + 8 (IP)	1TB	64GB	✓	✓	
(23)	MDR-508GW-1-G2-CMR	8 (Analogue) + 8 (IP)	1TB	64GB	✓	✓	✓
(24)	MDR-508G-1-G2-CMR(NA)	8 (Analogue) + 8 (IP)	1TB	64GB	✓	✓	
(25)	MDR-508GW-1-G2-CMR(NA)	8 (Analogue) + 8 (IP)	1TB	64GB	✓	✓	✓
(26)	MDR-508-1-G2-SSD	8 (Analogue) + 8 (IP)	1TB	64GB	✓		
(27)	MDR-508G-1-G2-SSD	8 (Analogue) + 8 (IP)	1TB	64GB	✓	✓	
(28)	MDR-508GW-1-G2-SSD	8 (Analogue) + 8 (IP)	1TB	64GB	✓	✓	✓
(29)	MDR-508G-1-G2-SSD(NA)	8 (Analogue) + 8 (IP)	1TB	64GB	✓	✓	
(30)	MDR-508GW-1-G2-SSD(NA)	8 (Analogue) + 8 (IP)	1TB	64GB	✓	✓	✓
(31)	MDR-508-2-G2-SSD	8 (Analogue) + 8 (IP)	2TB	64GB	✓		
(32)	MDR-508G-2-G2-SSD	8 (Analogue) + 8 (IP)	2TB	64GB	✓	✓	
(33)	MDR-508GW-2-G2-SSD	8 (Analogue) + 8 (IP)	2TB	64GB	✓	✓	✓
(34)	MDR-508G-2-G2-SSD(NA)	8 (Analogue) + 8 (IP)	2TB	64GB	✓	✓	
(35)	MDR-508GW-2-G2-SSD(NA)	8 (Analogue) + 8 (IP)	2TB	64GB	✓	✓	✓

Warning: Prior to attempting the system setup, please ensure the MDR 500 Series Installation & Operation Guide is thoroughly read and understood. Brigade will not be responsible for any failures due to incorrect installation or operation. Ensure your anti-virus software has exclusions in place to allow the MDR software package to function properly.

1.1 Product Features

1.1.1 Differences between MDR-504XX-X-XX-XXX(XX) and MDR-508XX-X-XX-XXX(XX)

MDR-504XX-X-XX-XXX(XX)	MDR-508XX-X-XX-XXX(XX)
500GB / 1TB / 2TB (2TB maximum) 2.5" HDD / SSD with anti-vibration mounting	1TB / 2TB (2TB maximum) 2.5" HDD / SSD with anti-vibration mounting
Industrial grade 32GB (256GB maximum) internal SD card for mirror, sub-stream and alarm recording	Industrial grade 64GB (256GB maximum) internal SD card for mirror, sub-stream and alarm recording
Simultaneous 6 channel recording up to: Analogue: FULL HD @25fps (PAL) / @30fps (NTSC) for 4 channels IP: 1080P @30fps for 2 channels	Simultaneous 16 channel recording up to Analogue: HD @25fps (PAL) / @30fps (NTSC) each or 8 channels at FULL HD @12fps (PAL) / @15fps (NTSC) IP: 1080P @30fps for 8 channels
4x Select video connectors typical to camera inputs with audio	8x Select video connectors typical to camera inputs with audio
Weight: 2.2Kg	Weight: 2.75Kg

1.1.2 Common to MDR-504XX-X-XX-XXX(XX) and MDR-508XX-X-XX-XXX(XX)

- Internal anti-vibration mount for the HDD or SSD
- Embedded super-capacitor for finalisation of recording after unexpected power interruption (up to 10 seconds)
- Individual channel configurations for recording resolution, frame rate and quality
- Anti-tampering feature – using digital code
- Display split 1/4/9 channels
- 2x EIA/TIA 485 (RS485) for optional External G-Sensor and Remote Status & Interface Panel
- Operation log files for troubleshooting
- Built-in G-Sensor
- Built-in Audible Buzzer
- GPS for location monitoring and tracking with external antenna
- I/O: 8x trigger input (trigger voltage 9V which can be set to trigger at low/high); 2x trigger output (12V max. 200mA)
- USB-B (3.0) interface on the Mobile Caddy Unit (MCU) for displaying video recordings on a Windows™ operating system using MDR-Dashboard 5.0
- USB-A (2.0) interface on the Docking Station (DS) for downloads, upgrades and configurations onto a USB flash drive (flash memory only, maximum 16GB)
- Pre-alarm recording 1-60 minutes and Post-alarm recording 0-1800 seconds. (0 to 30 minutes)
- Video quality selectable at 8 different levels for recording
- Video/Audio compression H.264/ADPCM
- Normal, Alarm or Timer recording modes
- Alarm recordings configurable for trigger, speed, G-Force, video loss, motion detection, blind detection, panic button, geo-fencing and HDD errors
- Low voltage protection with configurable shut-down delay and minimum restart voltage
- Ethernet 10/100/1000 RJ45 port for configuration, live view, playback and video download
- Mouse for configuration and recording/event search
- Shut-down delay configurable from 0 seconds to 24 hours
- 12V Output max 1A load
- 8.5-36V Power Input
- Operating temperature and humidity: -40°C to +70°C and 10% to 90%
- MCU swappable between different models. Note: if an MCU having 8 channels records will only be able to playback first 6 channels after install in an MDR-504xx model. If want to view all channels records, please use an MDR-508xx or MDR-Dashboard 5.0 to playback. No need to format when swapping, all MDR models are sharing the same file system. The recording will immediately start after install an MCU into the MDR docking station.

2 Kit Contents

2.1 MDR-504XX-X-XX-XXX(XX) and MDR-508XX-X-XX-XXX(XX) Kits

2.1.1 MDR-504XX-X-XX-XXX(XX)



MDR 500 Series 4 Channel Control Unit with 500GB / 1 TB / 2 TB HDD / SSD, GPS, 4G, Wi-Fi & 32GB SD Card (Depending on model)
MDR-504XX-X-XX-XXX-CU(XX)

2.1.2 MDR-508XX-X-XX-XXX(XX)



MDR 500 Series 8 Channel Control Unit with 1 TB / 2 TB HDD / SSD, GPS, 4G, Wi-Fi & 64GB SD Card (Depending on model)
MDR-508XX-X-XX-XXX-CU(XX)

2.1.3 Common for MDR-504XX-X-XX-XXX(XX) and MDR-508XX-X-XX-XXX(XX)



MDR GPS Antenna
MDR-ANT-GPS-02



MDR Mobile Network Antenna
MDR-ANT-MOB-01
(Depending on model)



MDR Wi-Fi Antenna
MDR-ANT-Wi-Fi-01
(Depending on model)



MDR Input / Output Cable
MDR-IO-01



MDR Power Cable
MDR-PWR-01



MDR USB A to B Cable (USB 3.0)
MDR-USB-B-02



MDR Mouse
MDR-MOUSE-01



MDR Brackets
MDR-BKT-01



MDR Security Key
MDR-KEY-01

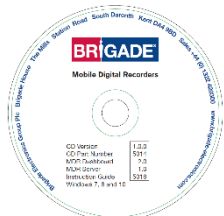

MDR Installation CD
MDR-500-CD

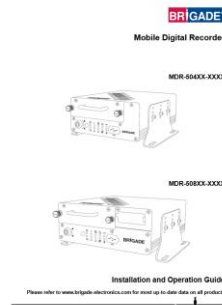

MDR 500 Series Installation and
Operation Guide
MDR-500-IG



7x MDR Bracket Fixing Screws
MDR-BKT-FIX-01

2.2 Optional Accessories

2.2.1 Remote Status & Interface Panel



MDR Remote Status & Interface Panel
MDR-RP-02-P



MDR 4m Cable for Remote Status & Interface Panel
MDR-04RPC

2.2.2 External G-Sensor



MDR External G-Sensor (Non-IP rated)
MDR-GS-02-G



MDR 2m External G-Sensor Cable
MDR-02GSC-02

Note:

- The internal or external G-sensor needs to be calibrated before use.

2.2.3 SD Cards



32GB Industrial Grade SD Card Class 10
SD-32GB-IND



64GB Industrial Grade SD Card Class 10
SD-64GB-IND

2.2.4 Fireproof Box with 32GB SD Card



MDR Fireproof Box with 32GB SD Card
MDR-400-FPB-32

3 Hardware Installation

Warning







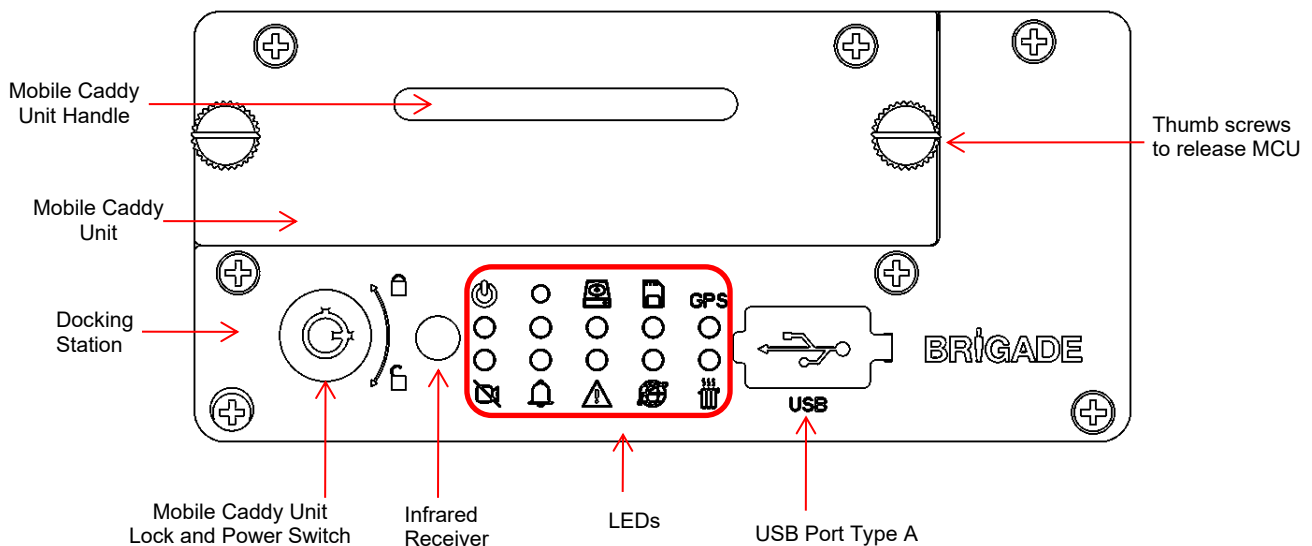



- Connecting any input or output wires to high voltages may damage the product. Brigade will not be responsible for any damage caused due to negligence.

3.1 Front View

3.1.1 MDR-504XX-X-XX-XXX(XX) Front View



MDR-504XX-X-XX-XXX(XX) Front View Figure 1

	Heater - Yellow LED ON: HDD Heater is on OFF: HDD Heater is off		Power – Blue LED ON: Power on or sleep mode OFF: Power off
	HDD - Blue LED ON: HDD detected Flashing: HDD is reading or writing OFF: HDD is not detected		Recording – Green LED Flashing: HDD recording OFF: HDD not recording
	SD - Green LED ON: SD card detected Flashing: SD card is reading or writing OFF: SD card is not detected		GPS – Green LED ON: GPS module is detected Flashing: GPS module transmitting data OFF: GPS module is not detected
	Network - Green LED (MDRs with mobile network and/or Wi-Fi functions) ON: Mobile network detected Flashing: Centre Server is connected (Data transmission to the Server) OFF: Mobile network is not detected		Alarm – Red LED ON: When an alarm is triggered, lasts for entire alarm duration OFF: Alarms not triggered or only events have been triggered
	Error - Yellow LED ON: HDD/INTERNAL SD not formatted; HDD/INT SD not installed; HDD/INTERNAL SD been damaged OFF: MDR working normally		Video Loss – Red LED ON: When a video loss occurs on an enabled channel OFF: All enabled channels have a video signal

3.1.2 MDR-508XX-X-XX-XXX(XX) Front View

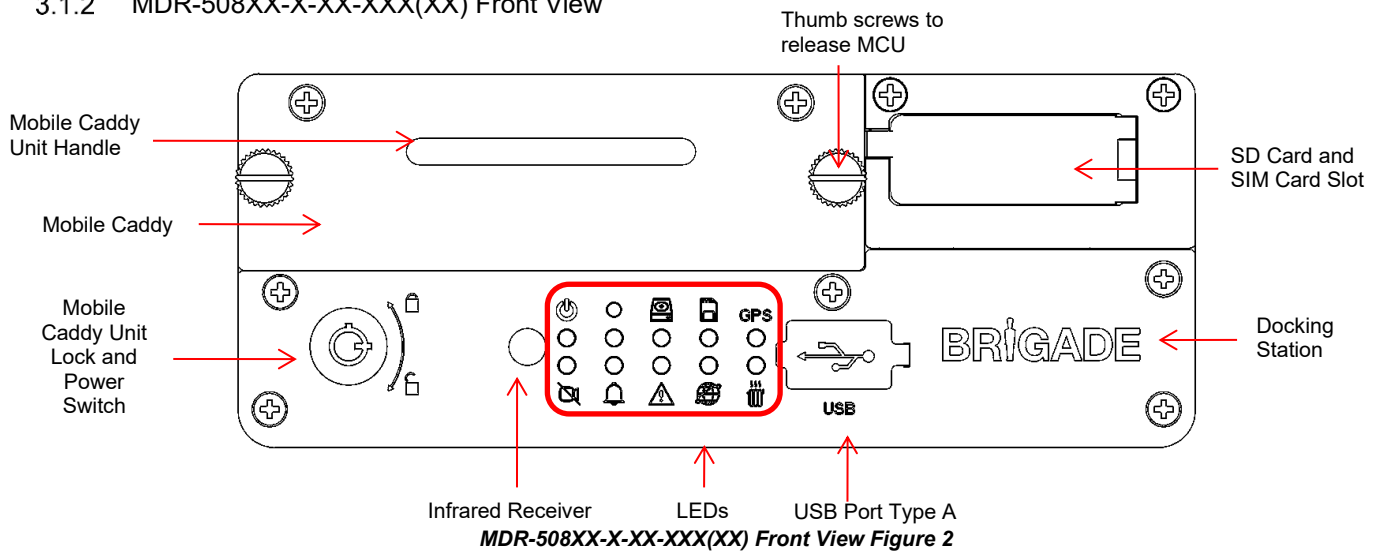

3.2 Rear View

3.2.1 MDR-504XX-X-XX-XXX(XX) Rear View

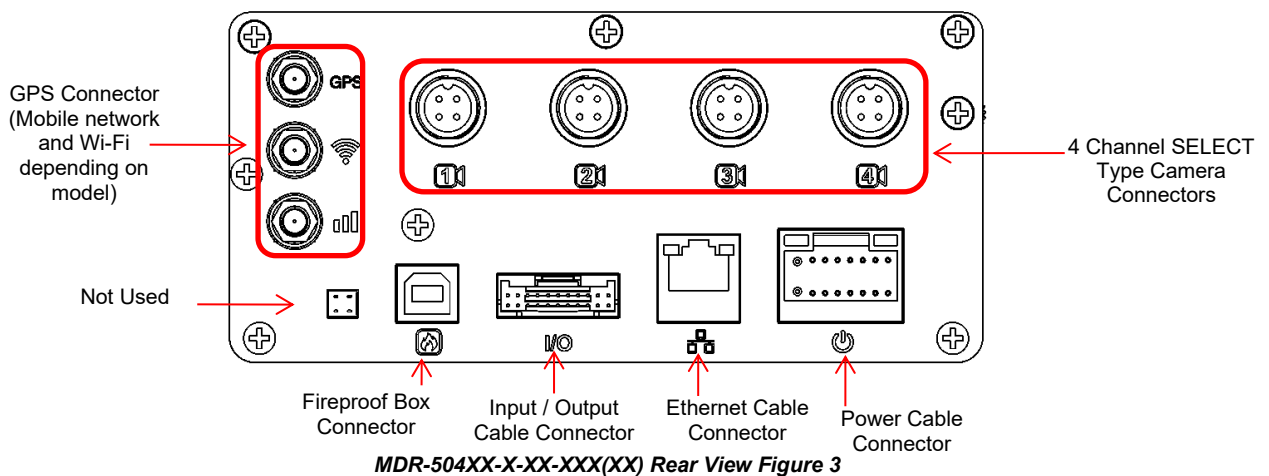

Rear Panel:

	Mobile Network Antenna Connector		Fireproof Box Connector
	Wi-Fi Antenna Connector		Ethernet Connector
	GPS Antenna Connector		Input / Output Cable Connector
	Power Cable Connector		Camera 1 Connector

3.2.2 MDR-508XX-X-XX-XXX(XX) Rear View

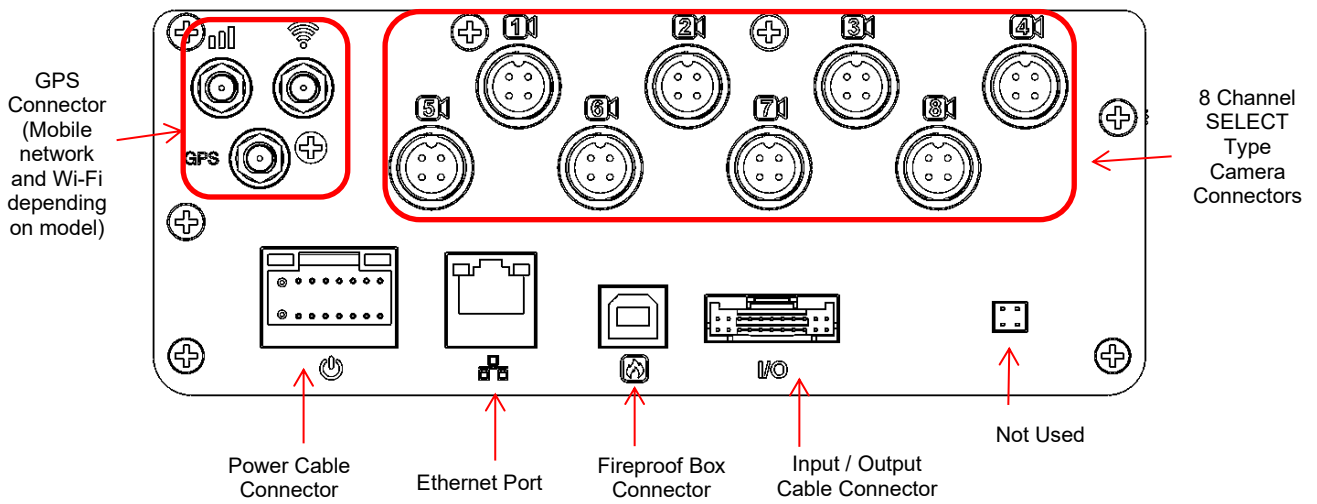

MDR-508XX-X-XX-XXX(XX) Rear View Figure 4

3.3 Mobile Caddy Unit (MCU Contains HDD)

3.3.1 MDR-500-X-MCU-XX-XXX

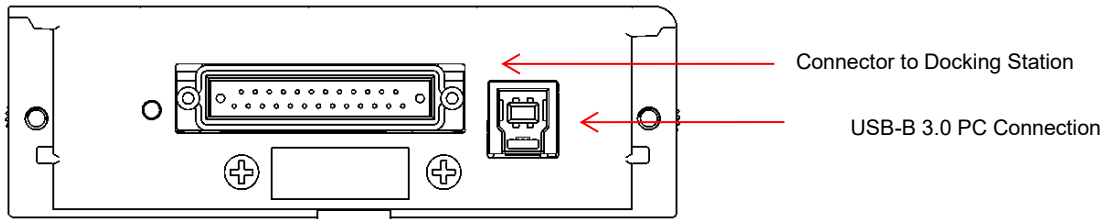

MDR-500-X-MCU-XX-XXX Figure 5

3.4 USB Mouse / Remote Control (Optional)



MDR-MOUSE-01 Figure 6

3.5 MDR-504XX-X-XX-XXX(XX) Connection Diagram

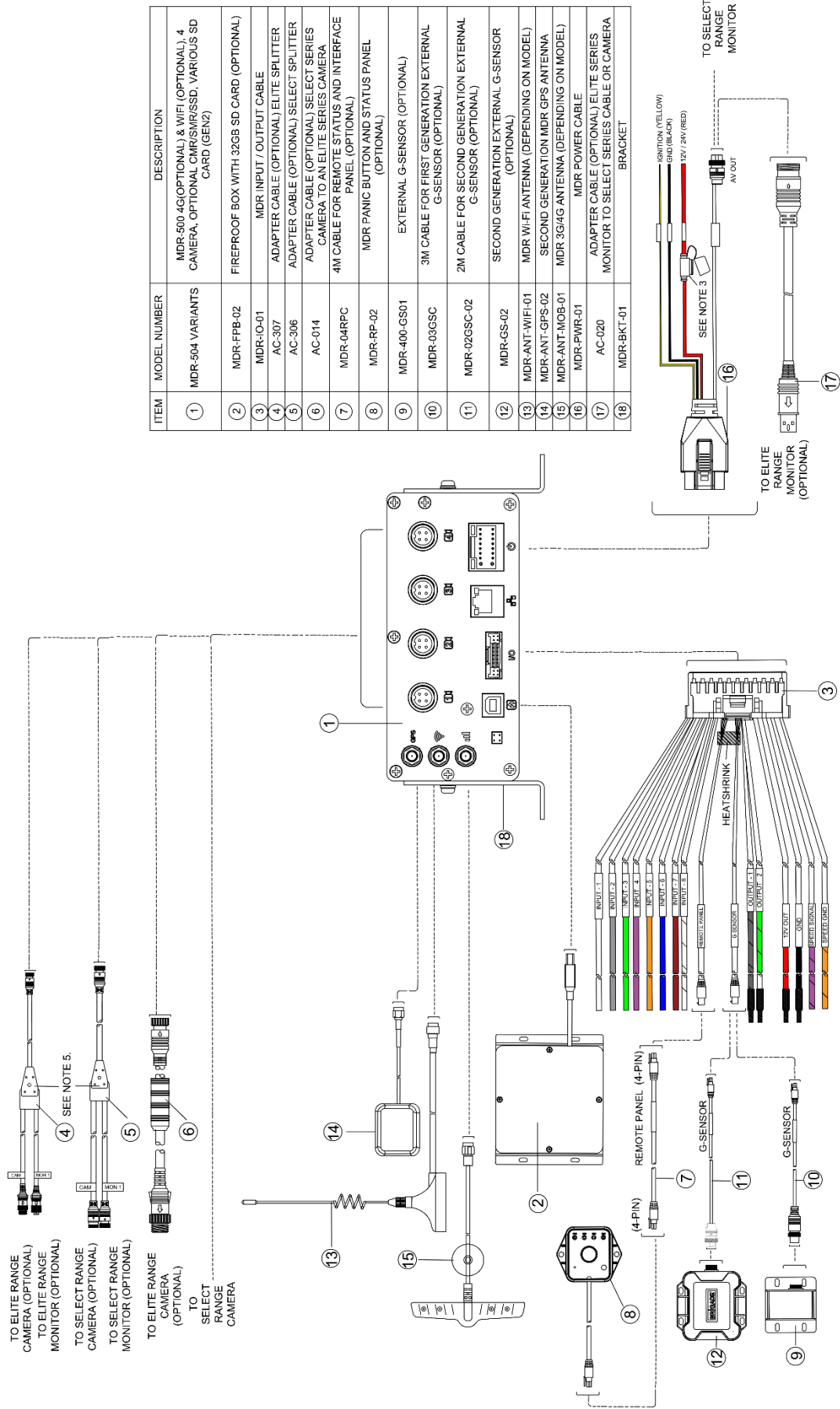

MDR-504XX-X-XX-XXX(XX) Connection Diagram Figure 7

3.6 MDR-508XX-X-XX-XXX(XX) Connection Diagram

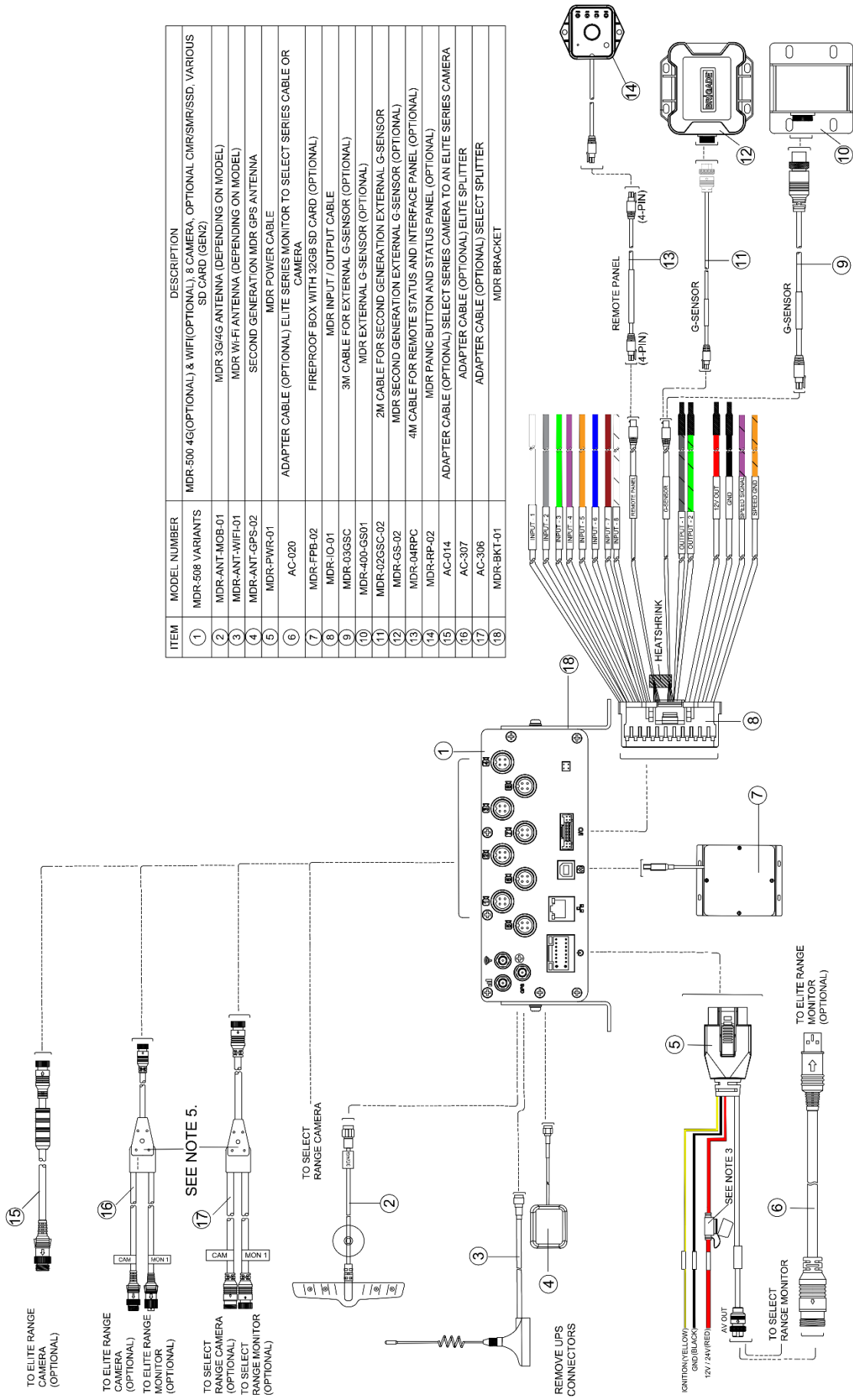

MDR-508XX-X-XX-XXX(XX) Connection Diagram Figure 8

3.7 Mobile Caddy Unit Removal

Warning: Follow the removal steps shown below. Failure to do so **will damage** the HDD. Ensure that the PWR LED indicates the MDR is OFF prior to removal. Make sure to format HDD/SD card after swapping, different MDR generations use different file systems which are not compatible with each other and will cause recording loss if not formatted in advance.

3.7.1 MDR-504XX-X-XX-XXX(XX) MCU Removal

- Step 1**
Unlock the MCU using the key
 - Step 2**
Confirm that the PWR LED is OFF
 - Step 3**
Completely undo the two thumb screws (anti-clockwise)
 - Step 4**
Gently pull the MCU by holding the front handle
- Note: If space is limited, the MCU can be removed in an upright direction

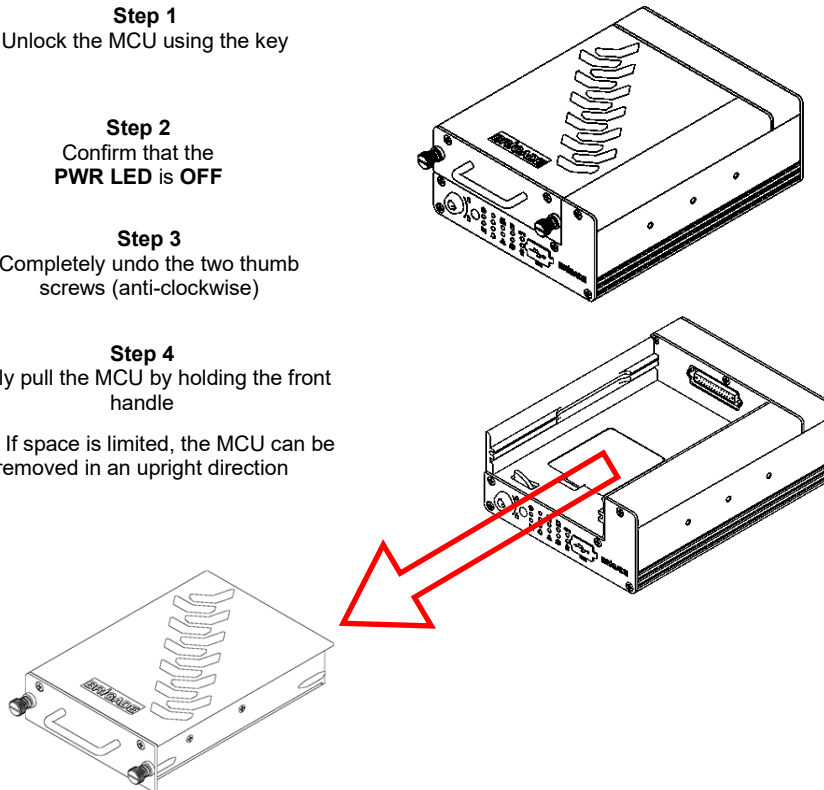

MCU Removal for MDR-504XX-X-XX-XXX(XX) Figure 9

3.7.2 MDR-508XX-X-XX-XXX(XX) MCU Removal

- Step 1**
Unlock the MCU using the key
 - Step 2**
Confirm that the PWR LED is OFF
 - Step 3**
Completely undo the two thumb screws (anti-clockwise)
 - Step 4**
Gently pull the MDR-500-X-MCU-XX-XXX by holding the front handle
- Note: If space is limited, the MCU can be removed in an upright direction

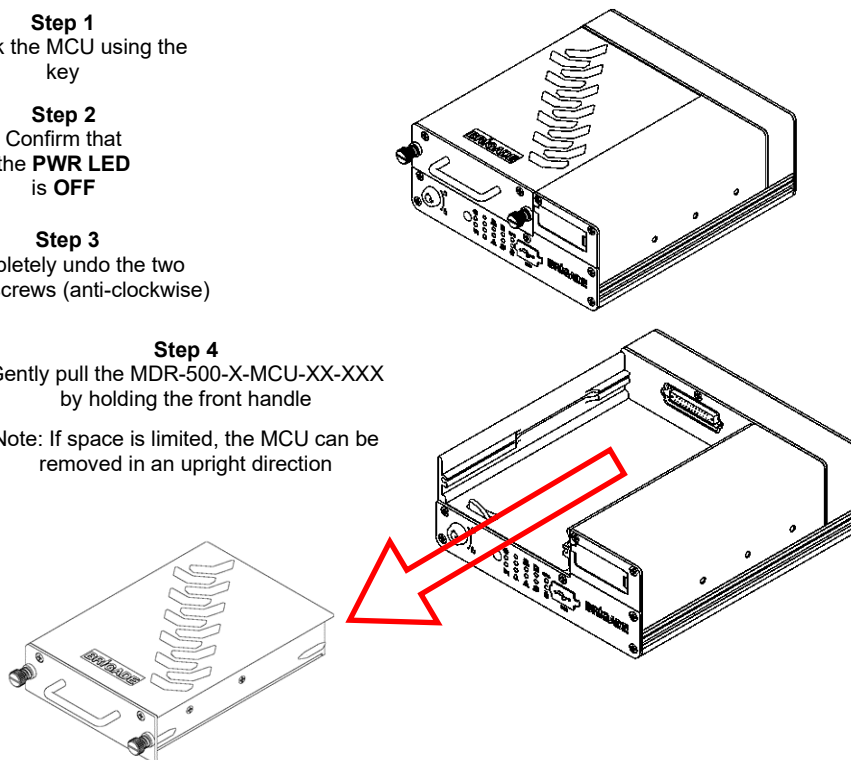

MCU Removal for MDR-508XX-X-XX-XXX(XX) Figure 10

3.8 SD Card Removal

Note: To remove an SD card from an MDR, the MCU needs to be removed first. Make sure the MDR is powered off before removing any storage medium. Failure to do so **will damage** the HDD/SD card. (see *SD Card removal for MDR-504XX-X-XX-XXX(XX) Figure 11* and *SD Card removal for MDR-508XX-X-XX-XXX(XX) Figure 12*).

3.8.1 MDR-504XX-X-XX-XXX(XX) SD Card Removal

- Step 1**
Unlock the MCU using the key and confirm the PWR LED is OFF
- Step 2**
Slide out MCU. Push the clip away from you while lifting the lid.
- Step 3**
The SD Card is placed in a SD card slot. Remove and discard the plastic tape covering the SD card. Push and depress the SD card to remove the card from its slot.

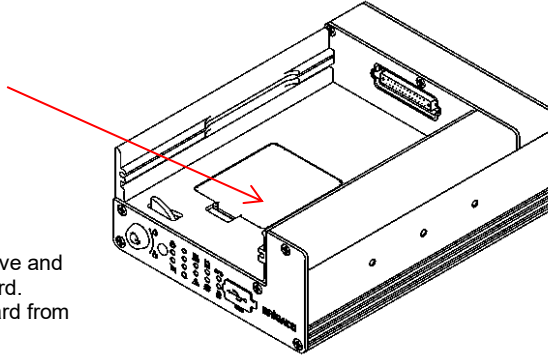

SD Card removal for MDR-504XX-X-XX-XXX(XX) Figure 11

3.8.2 MDR-508XX-X-XX-XXX(XX) SD Card Removal

- Step 1**
confirm the **PWR LED** is **OFF**
- Step 2**
Gently open the door marked (as indicated by the arrow on front of MDR-508-EXP) to reveal the SD card slot.
- Step 3**
Push and depress the SD card to remove the card from its slot. SD card are inserted with contacts facing upwards.

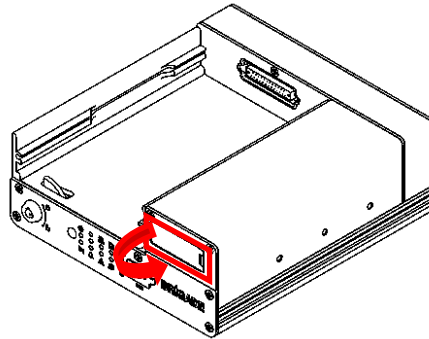

SD Card removal for MDR-508XX-X-XX-XXX(XX) Figure 12

3.9 SIM Card Installation

3.9.1 MDR-504XX-X-XX-XXX(XX) SIM card Installation

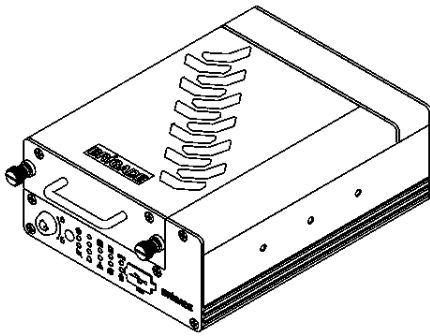

- Step 1**
Remove the MCU unit. This will allow you to access the SIM card slot. Make sure the PWR LED is OFF before removing the MCU. Failure to do so **will damage** the HDD.

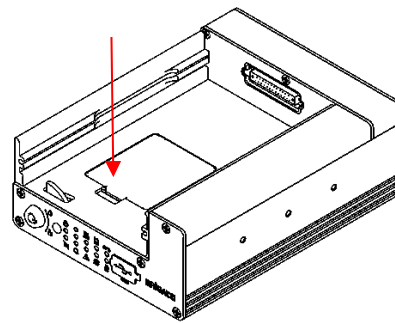

- Step 2**
Use the clip to flip the door open. Ensure an earthing strap is worn to prevent any damage to the PCB. Remove the film that is placed over the SIM card slot. Insert the SIM card with the contact pins face down. Push the SIM to lock the SIM securely in place.

MDR-504XX-X-XX-XXX(XX) SIM card Installation Figure 13

3.9.2 MDR-508XX-X-XX-XXX(XX) SIM card Installation/Expansion Module Upgrade

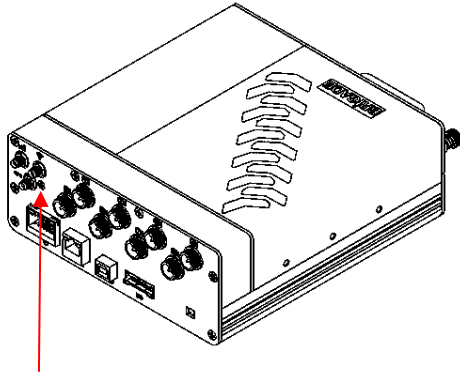

Step 1

Remove the MCU and open the expansion module door to access the SIM card slot. Confirm the **PWR LED** is **OFF**, failure to do so **will damage** the HDD. Insert the SIM card and push the SIM to lock the SIM securely in

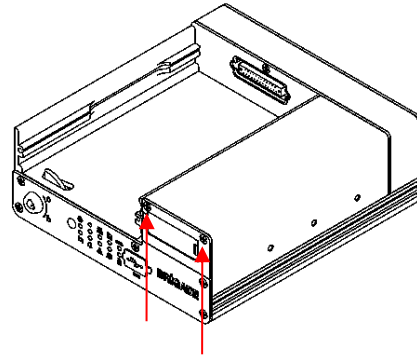

Step 2

Ensure an earthing strap is worn to prevent any damage to the PCB. Undo the screw on the rear panel (shown above left). Undo the two screws on the front panel of the expansion module (shown above right).

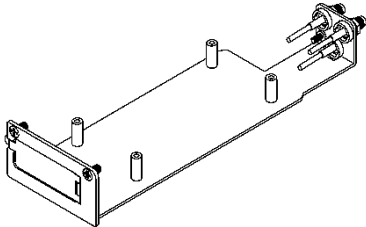

Step 3

Open expansion module door. Pull gently towards you to remove the expansion module. Insert the new expansion module by ensuring the base plate is sliding into the base grooves of the MDR.

This modular design allows for easy upgrading or downgrading of 8 channel MDR units. To upgrade to a mobile network/Wi-Fi solution, users need to swop the MDR-508XX-EXP to a model with these features.

MDR-508XX-X-XX-XXX(XX) SIM card Installation Figure 14

3.10 Antennae Installation

The information found in this sub-chapter may be found in the FCS1362:2016 UK CODE OF PRACTICE for the installation of mobile radio and related ancillary equipment in land-based vehicles. Please use this document for further details. Please see Appendix Chapter 17 General Antennae Guidelines for more information.

3.10.1 GPS antenna Installation (Included)

The GPS antenna needs to have an unimpeded view to the sky. The antenna positioning and orientation is critical to ensure effective operation. Horizontally mounted on a metal plate is optimum.

3.10.2 Wi-Fi antenna (Depending on Model)

Before a magnetic mount antenna is fitted both the underside of the base and the selected body panel surface should always be cleaned to avoid damage to the paint work.

- They must be directly placed on a flat area of steel
- They should not have any other material inserted between the magnetic base and vehicle body other than a protective pad or boot supplied by the antenna base manufacturer. This is to avoid reduction in the magnetic retention strength and any effect on the coupling to the ground plane.

3.10.3 Mobile Network antenna (Depending on Model)

On-glass antennas must be:

- securely fitted and fixed away from any metal which could deflect the signal
- located such that driver visibility is not impaired
- avoid heated screen elements
- mounted outside of the swept area of the windscreen

4 MDR On-Screen Display (OSD)

This chapter describes the configuration of the MDR.

Brigade's 500 Series MDR displays a start-up screen. See *MDR Initialisation Screen Figure 15*. During this period, the MDR completes a disk check which helps in identifying any file errors or bad sectors. In doing so, the MDR will avoid writing to these sectors to maintain data integrity.

If required, the MDR will attempt to repair any bad sectors prior to entering its recording state. The MDR 500 Series takes approximately 50 seconds to enter a recording state once ignition has been applied.

Warning: The start-up time to recording for the MDR 500 series is approximately 50 seconds. Please wait at least 3 minutes after ignition is applied. Brigade will not be responsible for any events not recorded during this start-up period. There are three ways in which a user can tell if the MDR is recording: a visible blue HDD and a green SD card on each channel; MDR REC LED will be on; Remote Panel REC LED will be on (optional accessory).



MDR Initialisation Screen Figure 15

4.1 Quick Menu

After initial ignition on the MDR, it displays a quad view for Channel 1 – 4 by default. See *Start-up Screen Figure 16*.

To access the quick menu, use the right button on the mouse . Right click the mouse to show the Quick Menu. Clicking this button again will make any currently displayed OSD disappear. The right button can also be used as a quick exit button.

By default, the quick menu appears on the bottom of the display area. Although, if this is blocking any key information, you may click, hold and drag the quick menu up or down to change its position. See *Quick Menu Position Changed Figure 17*.

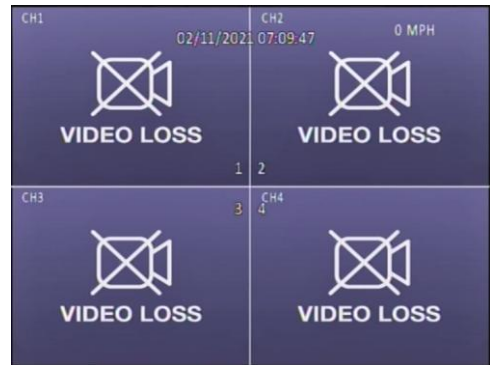

Start-up Screen Figure 16

Three different view options are available in the quick menu: **Single**, **Quad** and **9-Split**. See *Start-up Screen Figure 16*, *Single View Figure 18* and *9-Split View Figure 19*.

Playback requires login details to access; this will be covered in Chapter 5 *Record Search*.

Sys Info will be covered in Chapter 8 *System Information*.

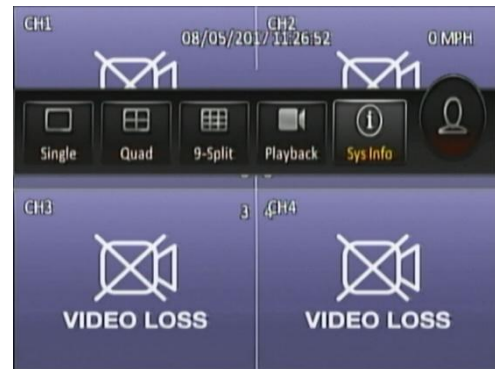

Quick Menu Position Changed Figure 17



Single View Figure 18



9-Split View Figure 19

4.2 Login

For MDR-504 series: By default, there are two user accounts: admin and user. The password for the **admin** account is **admin**. The password for the **user** account is **user**. We recommend changing the password after first login which must be documented and controlled by the company.

For MDR-508 series: By default, there are two user accounts: **admin** and **user**. If accessing settings when the MDR first boots up, a window will pop up requesting password setup for admin that meets the complexity requirements. After the password for admin has been set, the **user** account will retain its default password **'user'**, the default password must be changed to a complex password when the customer logs in to the user account for the first time.

Brigade recommend changing the password after first login which must be documented and controlled by your company. The new password should contain 8 to 16 characters, including uppercase, lowercase letters, numbers, and optionally special characters. Refer to *MDR508 Series Password not Fit Requirement Figure 23*.

After saving the new password, users need to input the correct password on the login window again, to successfully access MDR configuration menu.

Monitors should scale the MDR video output automatically, but some monitors do not do this. If your screen is being partially cut-off, the MDR output margins can be manually adjusted by navigating to Setup -> Surveillance -> Live View -> Preview -> Margins Setup. Ensure all white borders are visible. See 7.2.1.1 *Preview* for further details.

Note: When accessing the menu, recording continues without any interruptions.

Once the login is successful, the OSD menu is displayed. See *Menu Structure Figure 25*. The menu is navigated using mouse movement and the left button. See *MDR-MOUSE-01 Figure 6* for further information.

Prior to using the MDR please set the MDR to default settings and clear all history information.

Default settings are achieved by: **Setup → Maintenance → Reset → Factory Settings → Restore**.

Clear history information by: **System Info → History → Clean**.

A complete OSD map is found in Chapter 12 *On-screen Display Map*.

Language is supported in current MDR firmware versions. 9 language options in total, which are English, German, Italian, Portuguese, Spanish, French, Polish, Dutch, Russian.

Once you have logged in, the menu structure will be displayed as shown in *Menu Structure Figure 25*.

This menu consists of: Recordings Search, System Information, Log Search, Setup and Logout.

There are help buttons  found throughout the MDR OSD menu. These buttons contain additional information to help explain features, settings and functions.

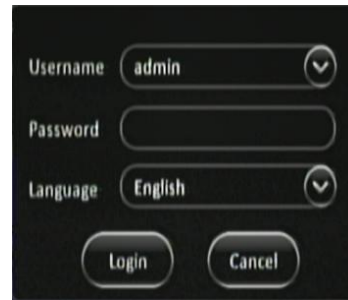

MDR Login Screen Figure 20

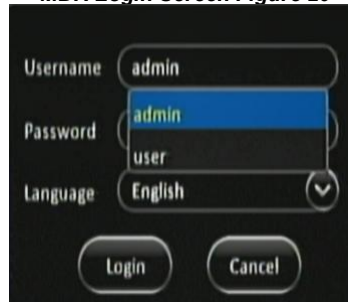

MDR Default Users Figure 21

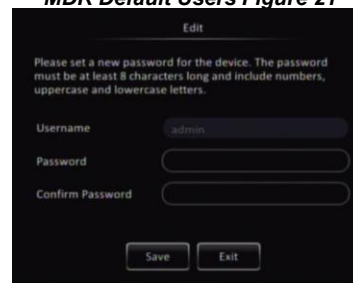

MDR508 Series Set Password Screen Figure 22



MDR508 Series Password not Fit Requirement Figure 23

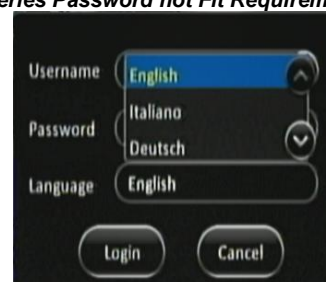

MDR Language Options Figure 24

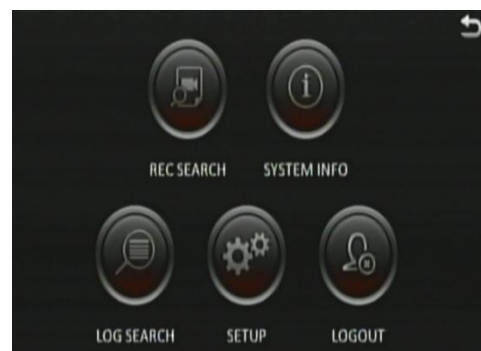

Menu Structure Figure 25

4.3 Logout

Logout is used to log off a user account that is used to access the MDR menu. Ensure that you log off once you have finished your configurations. See *Logout Figure 26*

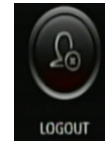

Logout Figure 26

5 Record Search

Rec Search allows you to search based on source, type, channel, date, month, year and time.

Source can be selected to retrieve the data. This can be HDD, Sub-stream SD or Main Stream SD. By default, HDD is selected. HDD recording represents higher quality recordings found on the HDD. This is usually set to a better resolution than Sub-stream SD data. Sub-stream represents a lower resolution recording that is found on the SD card. Main Stream SD represents recording the same data as the HDD, which is in high resolution and frame rates. SD data types will contain frame information only.

Once you have chosen the date, click **Next**.

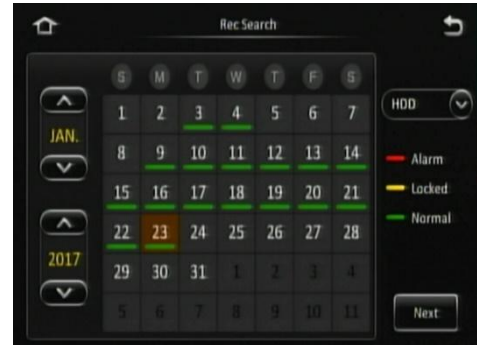

Rec Search Figure 27

Now the search results are shown, see *Search Results Figure 28*. **Video type** options are All, Normal or Alarm. If you are not certain of the type, choose All.

Channel lets you choose which channel video you would like to view. Each channel will be displayed in full screen.

Once you click **Search** the Video results are displayed. See *Video Results Figure 29*.

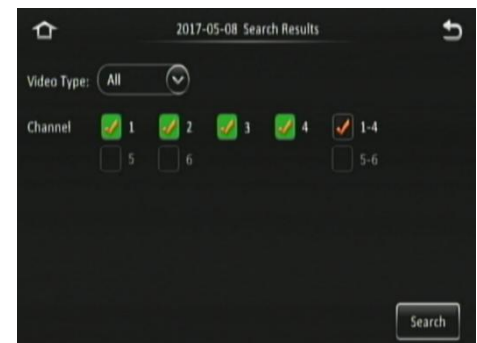

Search Results Figure 28

In this window, you will be able to choose a channel and time. Ticked channel boxes will load this data during playback.

If you click **Playback** it will automatically start playing Channel 1 when the video data starts for that day.

Note: If playback of a video recording is in a different video format from the current settings (example NTSC or PAL), it cannot be played. Please, switch the video format. You do this by navigating to Setup -> Surveillance -> Record -> General -> Video Format.

You can click on the timeline to a desired time or choose the time using the number pad . You can move the button to your chosen time, by clicking and dragging while left clicking.



Video Results Figure 29

is used to navigate earlier or later in that day.

is used to zoom in and out on the timeline.

During Playback, the following functions are available:

- | | | | |
|---------------------------------------|------------------------------|--|-------------------------------|
| | Show/Hide Volume menu | | Next Channel |
| <input type="text" value="01:09:21"/> | Choose time using number pad | | Previous Channel |
| | Volume Increase | | Rewind x2 x4 x8 x16 |
| | Volume Decrease | | Play / Pause |
| | Mute Volume | | Fast Forward x2 x4 x8 x16 |
| | | | Slow Forward 1/2 1/4 1/8 1/16 |
| | | | Step |
| | | | Back |



Playback Figure 30

Once you click **Export** in *Video Results Figure 29*, then *Start Time Export Figure 31* is displayed.

By default, the timeline for one whole day (24 hours) is displayed. Enter the start time of your export, once you are happy with the time, then click **Start time**. See *Start Time Export Figure 31*.

Enter the end time of your export and click **End time**. See *End Time Export Figure 34*. The duration and estimated capacity will be displayed. See *Error! Reference source not found..*

Once the start and end times are correct, insert a bus-powered USB hub into the MDR front USB. Then connect your mouse and USB Flash drive to this hub and click **Export**.

An export detail window will be shown, see *Error! Reference source not found..* Choose **Proprietary** or **AVI**.

Proprietary is secure and contains metadata, it is played using MDR-Dashboard 5. AVI is playable on industry media players such as Windows Media Player (WMP).

Errors can occur such as no external storage detected or a lack of memory space. If this does, unplug and replug the USB flash drive or insert a larger capacity flash drive. Click **OK**. Exporting progress will be shown in *Error! Reference source not found..*



Start Time Export Figure 31



End Time Export Figure 34



Export Estimate Figure 32



Export Details Figure 35

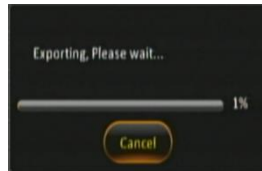

Exporting Progress Figure 33

6 Log Search

Log Search allows you to search based on type, date, month, year and time.

Click **Next** once you have chosen your required date.

In the next window, enter your **Start Time** and **End Time** of the period.

Log Type can be Alarm, Operation and Locked. Alarm logs contain logs related to Input/output triggers, Panic Button, Speed, G-Force, Video Loss, Motion Detection, Blind Detection and Geo-Fence. Alarm logs can be filtered. Operation logs show all logs related to MDR functions, see *Operation Log Figure 38*. Locked logs show logs related to files that are locked by the user. This is configured by the user.



Log Search Figure 36

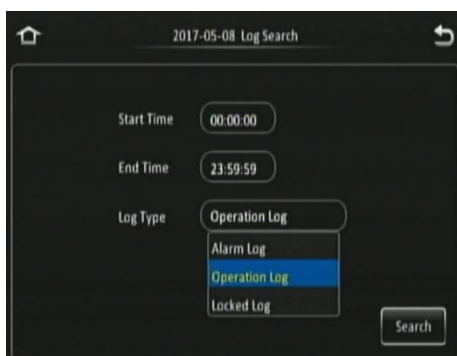

Log Details Figure 37



Operation Log Figure 38

7 Setup

This chapter describes the setup of the MDR. Settings related to basic setup, surveillance, events, alarms and maintenance. All settings are contained in the MDR Docking Station (DS). This means that Mobile Caddy Unit (MCU) swapping is easily supported if vehicle registrations are completed.

7.1 Basic Setup

Use **SAVE** which is located at the bottom of each page after making any changes.

Warning: Leaving a page prior to saving will cause changes to settings to be lost.

7.1.1 Register Information

7.1.1.1 Vehicle Information

Vehicle Registration is an important field which should always be populated. The vehicle registration is stored on the docking station and is then copied onto the current MCU recordings. This helps in identifying which vehicle the MCU was in at the time of recording. This is vital information if a fleet of vehicles swap MCUs.

Vehicle Number is typically used in fleet/bus applications where a vehicle has an associated fleet number. This can be captured in this field to assist in identifying the vehicle.



Vehicle Info Figure 39

7.1.1.2 Driver Information

Driver Number is typically used in fleet/bus applications where a driver has an associated number. This can be captured in this field to assist in identifying the driver in the event of an incident.

Driver Name may be populated which would make it easier in linking a driver's name with their number.



Driver Info Figure 40

7.1.1.3 Company Information

Company Name can be used in various type of fleets. The name filled in this blank will be synchronized to display on MDR-Dashboard 5.0 vehicle information section, which is under the vehicle fleet window.

Company Branch will make the vehicle information more detailed. Also, this will be displayed in the MDR-Dashboard 5.0 as well.



Company Info Figure 41

7.1.2 Time Setup

7.1.2.1 General

Date Format can be set to either DAY/MONTH/YEAR, YEAR-MONTH-DAY or MONTH/DAY/YEAR. By default, it is set to DAY/MONTH/YEAR.

Time Format can be either 24 Hours or 12 Hours. By default, it is set to 24 Hours.

Time Zone includes worldwide time zone options. By default, this is set to (GMT) DUBLIN, EDINBURGH, LONDON.

Default is found on most settings pages. This allows you to easily restore the factory settings for those settings.



Time Setup Figure 42

7.1.2.2 Time Sync

Date/Time can be entered manually here.

GPS should be ticked and the GPS antenna should be mounted in a vehicle location where signal can be achieved easily. This is the simplest and more reliable option.

NTP sync refers to network time protocol that is used to synchronize time with NTP Server PC time. This should only be used for mobile network or Wi-Fi MDR units.

Note: When GPS and NTP sync are enabled simultaneously, GPS takes highest priority. Only if GPS fails, NTP sync will be used by the MDR.



Time Sync Figure 43

7.1.2.3 Daylight Saving Time (DST)

Allows users to enter the date and time in which the Daylight-Saving Time will be activated. In the U.K, it starts on the last Sunday of March at 1:00 AM and ends on the last Sunday of October at 2:00 AM. Enter the correct time and date of the country in which the vehicle will be utilised. Whenever **DST** is not in use, turn this option to off.

DST Enable is enabled by default. This setting determines whether daylight savings time is active.

Start represents the month, date, day and time at which DST begins. By default, this is set to UK DST. If the time zone has been changed to another country, other than the UK, then the DST settings will need to be amended to reflect the selected country.

End represents the month, date, day and time at which DST finishes.



Daylight Saving Time Figure 44

7.1.3 Power

7.1.3.1 On/Off

On/Off Mode has three different modes: IGNITION, TIMER and IGNITION OR TIMER.

This option determines the conditions for which the MDR will power up. By default, it is set to **IGNITION**, which means that the MDR only turns on when an ignition signal is applied (yellow wire).

Note: Timer mode must not be used for extended periods of time – this will damage your vehicle's battery.

Non-stop allows the MDR to record infinitely. Enabling this will disable Shutdown Delay.

Warning: Using the MDR for prolonged periods of time without ignition (vehicle running) can drain the vehicle's battery. Recommend that the **Low Voltage Protection** feature is enabled. See 7.1.3.2 Voltage for details.

Shutdown Delay refers to the period the MDR will remain on and recording once the ignition has been turned off. The range is 0 to 86399 seconds (24 hours). By default, this is 600 seconds (5 minutes). The shutdown delay period may show up on the OSD for a period longer than your setting, please see the note below for an explanation.

Note: MDRs are required to be continuously on for approximately 6 minutes. If an MDR has not been continuously on for 6 minutes, MDR shutdown



On/Off Figure 45

delay will be equal to 6 minutes minus MDR on time plus your current shutdown delay period.

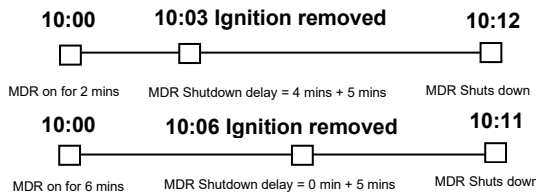

MDR Shutdown Delay set to 5 mins

Timer From becomes active once an On/Off Mode that includes timer is chosen.

7.1.3.2 Voltage

Low Voltage Protection Enable is off by default. This feature is important to use to protect your vehicle's battery from damage. Ensure this feature is activated when using the non-stop shutdown delay feature.

Low Voltage is the voltage level which is a dangerously low value. For a 24V vehicle, the limits are from 21V to 23.5V. For a 12V vehicle, the limits are from 8V to 11.5V.

Start-up Voltage refers to the minimum voltage the MDR must receive before powering on. For a 24V vehicle, the limits are 24V to 26V. For a 12V vehicle, the limits are 12V to 14V.

Observe Time is the amount of time the low voltage value must be observed for. This is to ignore any sudden dips in voltage that recover.

Shutdown Delay is a countdown which begins once the observe time has been completed. This countdown is displayed on the MDR OSD. LV represents low voltage. See *Low Voltage Shutdown Delay Figure 47*.

Low Volt Upload (scroll down on OSD using ) can only be used if a wireless or mobile network MDR is used. MDR Server software is a requirement for this feature. Once the MDR detects a low voltage level, it will send this data back to the MDR Server where it gets stored. This can then be reviewed later. Depending on MDR model.

Proposed Low Voltage Protection Settings for lead-acid batteries (Note: Please check if these are suitable for your vehicle):

12V Vehicles	24V Vehicles
Low Voltage:11.7V	Low Voltage:23.7V
Voltage of Start:12.5V	Voltage of Start:24.5V
Observe Time:15 minutes	Observe Time: 15 minutes
Shut Down Delay:5 minutes	Shut Down Delay:5 minutes

Sleep is a temporary standby status which enables MDR to automatically wake up from time to time to complete MDR-Dashboard platform issued Auto-download tasks. By default, it's off. This feature aims for saving vehicle battery consumption while MDR is lined up waiting for its turn to download footage to MDR server.

Sleep Duration is MDR will stay in sleep mode for how many hours.

Periodic Wake-up represents after how many minutes the MDR will wake up (boot up) to start the auto-download tasks.

Note:

- 3-time check-up:** If MDR cannot detect auto-download (ADS) tasks (likely no task assigned), it will wake up after ignition off only 3 times to check with the platform then shut down completely, ignoring the Sleep Duration settings for better saving vehicle battery usage. If MDR has ADS tasks, after task completed, it still has the 3-time check-up before shut down.
- If Sleep Duration time ends before ADS task started, MDR will end the sleep mode and shut down completely.
- If Sleep Duration (1 hour) set value less than Periodic Wake-up (65 min), MDR will wake up at 65 minutes, and act differently when:
 - There's an ADS task but it's not its turn to start download: MDR will shut down because the sleep duration is over.
 - There's an ADS task and Wi-Fi available for download: MDR will complete the task then shut down, no 3-time check-up because the sleep duration is over.
 - There's no ADS task: MDR will shut down because the sleep duration is over.



Voltage Figure 46

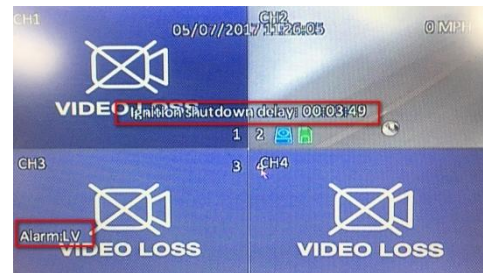

Low Voltage Shutdown Delay Figure 47



Sleep mode Figure 48

7.1.4 User Setup

Menu Idle Time refers to the period for which the menu will remain active and logged in. Once this period finishes, the MDR will automatically log off the user.

Username is the name you use to log onto the MDR. By default, there are two usernames: admin and user.

User Group represents the level of access to the MDR OSD. There are only two types: Admin and Normal User. Admin has access to all settings and features. Normal User has restricted access: sys info, playback and export logs and videos.

Add is used to create additional user accounts. A maximum of three user accounts can exist.

Edit is used to change existing user account details.

To remove any password requirements, save the user account with a blank password.

Check Password is used to allow MDR-504 series check the login password. If the password is default or vacant, a notification window will pop up every time after MDR boot up to notify driver to change the password to a more complex combination. By default, it is on.

Note: if click “No” on the start up screen notification window, it will automatically disable the Check Password and prevent the notification to show up again.

MDR-508 series equipped with mandatory password complexity requirements, the **Check Password** is not needed.



User Setup Figure 49

7.1.5 HDD Key

Disk Drive Protection used for encrypting HDD / SSD data while using MDR-Dashboard to read the MCU by USB cable. By default, it is off.

After enabling this feature, the MDR-Dashboard client will have a verification window pop up before loading video data. See *MDR-Dashboard Input HDD Password Figure 51*. The HDD key cannot be wiped out by formatting the MCU, and it also not packed in MDR config file for security purpose.

HDD Password is used to setup a new password or reset current password. Password combination must contain numbers, capital and lower-case characters. (Empty password is also accepted)

OLD Password is used for confirming previous password before reset to a new password. If user did not input the old password or type in wrongly, the reset process will be failed.

Warning: The HDD Key section is not auto-adapt to current HDD status. For e.g., MDR A has HDD key 1, MDR B does not enable the HDD key feature. If swapping both MCUs, after MCU A installed on Docking Station B, the MDR OSD will still show feature disabled. If user want to disable the feature in MCU A, they need to enable then disable again to make it effective. Also, if one MCU without password has been installed on a MDR which enabled the HDD key, the key will be automatically written into the MCU.

MDR OSD cannot reflect its real time status. Therefore, strongly suggest if using this feature please do not swap MCU between units.



HDD Key Figure 50

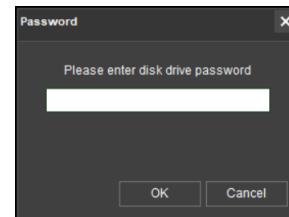

MDR-Dashboard Input HDD Password Figure 51

7.1.6 Network

7.1.6.1 Ethernet

There are two modes available for Ethernet adaptor addressing, DHCP and Static.

DHCP Mode refers to the Ethernet adaptor of the MDR obtaining an IP address automatically from the network.

Static IP is used to specify the exact network details you would like the MDR Ethernet adaptor to use.

IP Address refers to the internet protocol address of the Ethernet adaptor. This address is used to access the MDR Ethernet menu via LAN cable. Recommended to ask your internal IT for information and assistance.

Subnet Mask is used to identify network address of an IP address. By default, this is 255.255.255.000.

Gateway helps route the network traffic. By default, this is 192.168.001.254.

Obtain DNS Automatically refers to the domain name system. A DNS server takes the website addresses that you type in and resolves them into the actual IP address of the site. While MDR attempts to get an IP address for itself from the DHCP server, it will simultaneously attempt to resolve address.

Use Following DNS the MDR will use these DNS addresses regardless of what the DHCP server is using.

Preferred DNS Server by default, this is 008.008.008.008.

Alternate DNS Server by default, this is 008.008.004.004.

7.1.6.2 Ports

For MDR504 Series: **Web Port** is used for when a PC is connecting to the MDR Ethernet page. If this is incorrect, the web page will not open. By default, this is 80.

For MDR508 Series: **Ethernet HTTPS** ensures that communication between the MDR and its Ethernet page is encrypted. By default, this is enabled for communication security.

Web Port is used for when a PC is connecting to the MDR Ethernet page. If this is incorrect, the web page will not open. When **Ethernet HTTPS** is enabled, the port is 443 by default. When it is disabled, the default port is 80 for non-HTTPS communication.

SMACON TLS is used for when Smartcontroller APP is connecting to the MDR via TLS encryption. By default, this is enabled for communication security.

Note: After SMACON TLS has been enabled, please make sure to enable TLS on the SmartController Apps login page before operation; otherwise, the login will fail.



Ethernet 1 Figure 52



Ethernet 2 Figure 53



MDR504 Series Ports Figure 54



MDR508 Series Ports Figure 55

7.1.6.3 Wi-Fi

These settings are dependent on your MDR model. This requires a wireless MDR model or any MDR model with external Wi-Fi dongle connected through Ethernet port.

Enable is used to turn the Wi-Fi module off or on. Once enabled, the settings found below will become active.

SSID is the service set identifier. It is used to identify a wireless LAN and is usually unique to an area. This is where you will enter the name of the wireless network that the MDR will connect to.

Encryption refers to protocols used to protect your network. MDR supports WEP and WPA/WPA2. We suggest using WPA2, as it is the newest encryption form and thus the most secure. This is case-sensitive.

Password is the wireless network password, this should be entered carefully as it is case-sensitive.

Static IP is used to turn the Wi-Fi module off or on. Once enabled, the settings found below will become active.

IP Address refers to the internet protocol address of the Wireless module. This address is used to join the wireless network.

Subnet Mask is used to identify network address of an IP address. By default, this is 255.255.255.000.

Gateway helps route the network traffic.

***Share Network** - MDR Wi-Fi Network can shared with other devices after connecting with Ethernet cable. The second device local IP address should set to 10.100.100.xxx (from 2 – 254 and avoid IP camera address if use any). Subnet Mask: 255.255.255.0. Gateway: 10.100.100.1. DNS: 8.8.8.8 or other public DNS servers.



Wi-Fi 1 Figure 56



Wi-Fi 2 Figure 57

7.1.6.4 Mobile Network

These settings are dependent on your MDR model. This requires a mobile network MDR model or any MDR model with external 4G dongle connected through Ethernet port.

MTU is used to adjust MTU (Maximum Transmission Unit).value for optimize your network transmission. By default, set to 1500.

Enable is used to turn the mobile network module off or on. Once enabled, the settings found below will become active.

Server Type is an auto-populated field, indicates the mobile network connection type.

Network Type refers to the type of mobile network connection that is used by the MDR to connect to the internet. Currently 4G is the fastest connection speed.

APN refers to Access Point Name. This information is dependent on your mobile carrier network.

Username obtain from your SIM card provider.

Password obtain from your SIM card provider.

Access Number refers to the dial up phone number needed to connect to the network. By default, this is set to *99#

Certification refers to the authentication mode, can be set to either CHAP (Challenge Handshake Authentication Protocol) or PAP (Password Authentication Protocol). CHAP should be chosen as this is a more secure authentication protocol. This is chosen by the network operator.

SIM Phone Number is not a required field. You may enter the phone number of the SIM card found inside the MDR for future reference.

***Share Network** - MDR Mobile Network can shared with other devices after connecting with Ethernet cable. The second device local IP address should set to 10.100.100.xxx (from 2 – 254 and avoid IP camera address if use any). Subnet Mask: 255.255.255.0. Gateway: 10.100.100.1. DNS: 8.8.8.8 or other public DNS servers.



Mobile Network 1 Figure 58



Mobile Network 2 Figure 59

7.1.6.5 Server

For MDR504 Series:

Center Server refers to the MDR Server. A maximum of 6 centre servers can be saved.

Add adds another centre server, a new blank page is displayed with a new number.

Delete removes the currently displayed centre server.

ON enables the current centre server.

Protocol Type refers to the protocol used by the MDR unit to send its data (video and metadata) to the MDR Server. By default, this is set to MDR5. Maintenance is not currently used.

Network Mode refers to the network communication module used for to communicate with the MDR Server. The options are Ethernet, Mobile Network and Wi-Fi. This is discussed in further detail in *MDR 500 Series Network Connectivity SW&Infrastructure Manual*. This can be found on the Brigade website.

MDR Server IP Public IP address of the firewall which forwards any traffic to the server PC or IP address of the server PC hosting the MDR Wi-Fi Server. (Domain name also supported).

MDR Server Port is used for device access to server. By default, is 5556.

Media Server IP should be the same as MDR Server IP.

Media Server Port should be the same as MDR Server Port. By default, is 5556.

For MDR508 Series:

Center Server refers to the MDR Server. A maximum of 6 centre servers can be saved.

Add adds another centre server, a new blank page is displayed with a new number.

Delete removes the currently displayed centre server.

ON enables the current centre server.

TLS Enable encrypts communication between the MDR and the Server. This is recommended to enable if the server deployed with HTTPS.

Verify Certificate ensures the authenticity of the server's certificate during every TLS connection attempt once the server's root certificate and revocation list (CRL optional) are imported into the MDR. The connection is allowed only after successful verification. This feature is disabled by default.

Note: If enable this feature, importing the server's root certificate is mandatory prior to use; otherwise, server connections will fail. For importing root certificate and CRLs, please refer to Chapter 7.5.7 Certificate

Protocol Type refers to the protocol used by the MDR unit to send its data (video and metadata) to the MDR Server. By default, this is set to MDR5. Maintenance is not currently used.

Network Mode refers to the network communication module used for to communicate with the MDR Server. The options are Ethernet, Mobile Network and Wi-Fi. This is discussed in further detail in *MDR 500 Series Network Connectivity SW&Infrastructure Manual*. This can be found on the Brigade website.

MDR Server IP Public IP address of the firewall which forwards any traffic to the server PC or IP address of the server PC hosting the MDR Wi-Fi Server. (Domain name also supported).

MDR Server Port is used for device access to server. When TLS function is enabled, it uses TLS port, by default, it is 6556. When TLS function is disabled, it uses TCP port, by default, it is 5556.

Media Server IP should be the same as MDR Server IP.

Media Server Port should be the same as MDR Server Port. By default, it is 6556 or 5556, depends on whether enabled TLS.

Note: If the device is to use the TLS feature, please report it to MDR-Server 6.0 at 2.6.3.50.75 version or later.

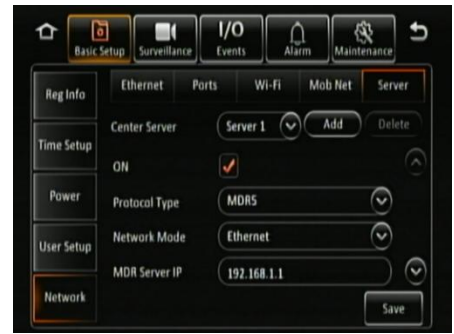

MDR504 Series Server 1 Figure 60



MDR504 Series Server 2 Figure 61



MDR508 Series Server 1 Figure 62



MDR508 Series Server 2 Figure 63

7.1.7 Application

7.1.7.1 FTP Server

FTP Enable is for set up an FTP server for storing snapshots. The FTP is used for building up a channel between software and MDR hardware, which allows users to download footage or snapshot through MDR-Dashboard 5.0. Recommend enabling it all the time.

Server is filled in by default, recommend not to change.

Port is set by default, recommend not to change.

User name is for the FTP server login.

Password is for the FTP server login, void by default.



FTP Server Figure 64

7.2 Surveillance

7.2.1 Live View

7.2.1.1 Preview

Note: The MIRROR and FLIP VERTICAL feature affects both the live and recorded views.

Live Audio is used to send real-time audio from a microphone enabled camera to a speaker enabled monitor. By default, this is disabled.

Image Setup is used to control BRIGHTNESS, CONTRAST, COLOUR and SATURATION. By default, this is set to mid-point (31). Each channel can be setup individually. All Settings (except mirror and flip vertical) can easily be duplicated across all channels by using the COPY TO button.

A MIRROR and FLIP VERTICAL button may also be configured per channel.



Preview Figure 65



Image Setup Figure 66

Margins is used to adjust the MDR displayed output, this is a key feature to adjust. By default, MARGIN-TOP is 20, MARGIN-BOTTOM is 20, MARGIN-LEFT is 45 and MARGIN-RIGHT is 45.

Start-up Screen refers to the configuration the MDR will display once it has fully booted up. The options are SINGLE, QUAD and 9-SPLIT. By default, a 4 channel MDR will have quad and an 8 channel will have 9-split.

Channel controls which cameras that you want to show on Start-up Screen. If IP cameras are connected but 5 and 6 are not ticked, then the IP camera will not show.



Margins Figure 67

7.2.1.2 Autoscan

Autoscan Enable must be ticked to enable all the options.

Screen is used to identify the different autoscan views.

Delete removes autoscan views.

Edit Screen is where autoscan views are setup.

Mode refers to layout options, such as single, quad, 9-split (8CH only).

Layout is where you choose your channel arrangement.

Duration refers to time displaying the autoscan. 1-300 seconds.



Autoscan Figure 68

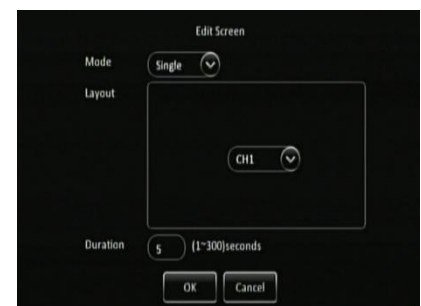

Edit Screen Figure 69

7.2.1.3 Live OSD

This refers to information that is displayed on the live monitor view at all times.

The options are: Date/Time, Vehicle Reg, Alarm, Vehicle Num, Recording State, Speed, GPS, Channel name and G-Force.

You can change the position of each live OSD by using the **Setup** button. Recording states' position is fixed and cannot be changed. This will be displayed in the setup screen.



Live OSD Figure 70



Live OSD Position Figure 71

7.2.1.1 RTSP

This feature only available in Ethernet page. It provide RTSP streaming link for third party media player user.

Select Module to choose which communication method MDR will be used for streaming transmission. 3 options available: Ethernet, Wi-Fi and Mob Net.

Enable to allow which channel can pull video stream to third party media player. Main stream and Sub-stream available. (Main stream and Sub-stream parameters setting see 7.2.2 Record)

Channel automatically adapt to MDR models. 6 channels available for MDR 504, 16 for DR 508.

RTSP Address used for input to third party player to obtain live streaming.

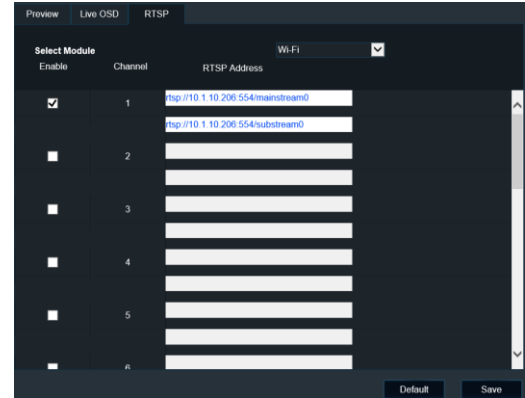

RTSP Figure 72

7.2.2 Record

7.2.2.1 General

Video Format is used to choose the output video format. The options are PAL - AHD or NTSC - AHD. By default, PAL is chosen. This will be the same for all camera inputs.

Note: Brigade's monitors have automatic detection of these standards.

HDD/SD Overwrite refers to when an HDD and SD cards will overwrite its stored data. The options are BY CAPACITY, BY DAYS and NEVER. By default, BY CAPACITY has been selected which means that when retention expires, locked files will automatically be unlocked and overwritten. Once the HDD has 4GB of space remaining (1GB for SD card), older recordings are erased and replaced by newer recordings except locked files. The NEVER option is when overwrite is deactivated. The MDR will stop recording when the HDD reaches 2GB of free space. The user must either replace the storage or manually delete recordings.

Note: If records time conflicts, for example, crossing time-zone which cause time change 1 hour ahead. Records during the overlapping timeline won't be covered or erased, still saved in the storage medium, but can't be playback by MDR. Recommend exporting the conflicting video out through USB port on front panel then use MDR-Player 5.0 to playback the certain footage as needed. Refer to Conflict Footages Show in Computer Figure 74

Locked File Retention This represents the length of time (in days) for which alarms cannot be overwritten by the MDR. When the retention expires, the locked files will automatically be unlocked and deleted.

Alarm Pre-recording This value specifies the length of time prior to an alarm recording. This will be added before the actual alarm. For example, if ALARM PRE-REC is set to 10 minutes and an alarm of 5 minutes is triggered at 4:00pm and ALARM POST REC is 180 seconds, the alarm recording will begin at 3:50pm and will end after 4:08pm. See Chapter 7.4 Alarms for more information.



Record Figure 73

- CH01-20190610-083959-095025.264
- CH01-20190610-085008-095959.264
- CH02-20190610-083959-095025.264
- CH02-20190610-085008-095959.264

Conflict Footages Show in Computer Figure 74

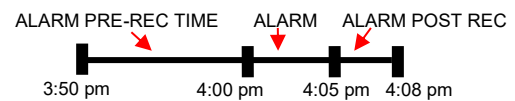

7.2.2.2 HDD

These settings are used to set the resolution, frame rate and quality per channel independently.

Channel is used to identify the channel. 1 to 6 for 4 channel models and 1 to 16 for 8 channel models.

Channel Name is used for an 8-character name which each camera channel can be associated with. These can include lower/upper alphanumeric characters. This is displayed on the live OSD.

Enable Recording allows the activation/deactivation of the camera channel. This should be used if not all camera channels are utilized to avoid video loss errors. When using a 4 camera MDR, channels 5 and 6 are not accessible because they are IP camera dedicated channels. Users need to enable them firstly in IPC Setup page. When using an 8 camera MDR, channels 9-16 are not accessible, the same reason as above.

Resolution allows users to choose the resolution for each channel. The options auto adjust based on camera inputs. The options are: CIF (lowest), WCIF, HD1, WHD1, D1, WD1 and AHD (720p and 1080p) (highest). For 4 channel models, you can set FULL HD 1920x1080 @25fps (PAL) / @30fps (NTSC). For 8 channel models, you can set FULL HD 1920x1080 @12fps (PAL) / @15fps (NTSC). By default, it is D1. AHD will only show when an AHD camera is connected to the MDR. Refer to 19 Specifications for further information on each resolution.

Frame Rate allows users to choose different frame rates for different channels depending on resolution settings. Options are 1 to 25 for PAL and 1 to 30 for NTSC. By default, it is 20.

Quality has 8 levels. Level 1 is the best quality whereas level 8 is the lowest quality.

Record Mode has three modes available – all modes require the IGNITION signal to be applied, or timer auto-boot to be set up:

- **NORMAL** - allows continuous recording after powering up until the device shuts down. Alarm recording is included in this mode.
- **ALARM** - allows users to record only when an alarm has been triggered. Alarms can be configured to be activated by triggers or other alarms (such as under/over speed, G-Force, Panic Button, etc.)
- **TIMER** - allows users to specify timeframes in which the recording will be activated. Refer to the OSD map to program these timeframes.

Record Mode - Timer - Schedule allows users to choose schedules based on different days.

Click on the day and choose the desired day of the week. Then setup the Start Time, End Time and Video Type.

Video Type can be Normal or Alarm.

Note: This record mode timer prevents an MDR from turning off, but this timer is unable to control when an MDR turns on. This has a higher priority than the ON/OFF TIMER.

Audio activation allows users to enable/disable the audio recording from the camera channels individually. This setting depends on the utilised cameras having microphones.

Record Rate Users may choose either Normal or I-Frame. I-Frame allows the recording of 1 frame per second for all channels to save recording space although there is a loss of smoothness during playback.

Alarm Quality has 8 levels. Level 1 is the best quality whereas level 8 is the lowest quality. Brigade recommends using a higher quality for Alarms for a higher level of image detail.

Encode Mode refers allows users to choose between Constant Bit Rate (CBR) and Variable Bit Rate (VBR). The difference is minimal as the Variable Bit Rate is not efficient as it involves more processing power and may introduce some visible artefacts due to higher compression rates.

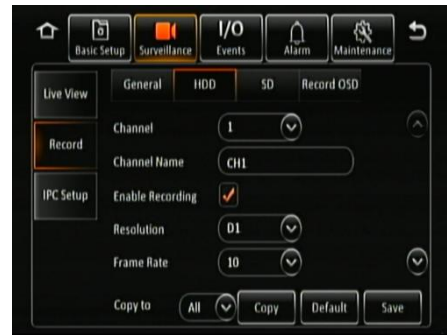

HDD 1 Figure 75



HDD 2 Figure 76

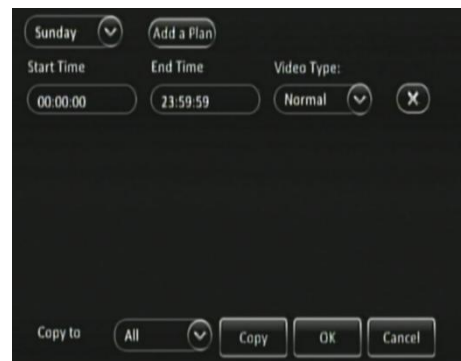

Record Mode – Timer Figure 77



HDD 3 Figure 78

7.2.2.3 SD

Record Storage options are Internal SD or fireproof box. A fireproof box (optional accessory) is connected to the MDR via its USB-B port on the rear. By default, internal SD is chosen.

Record Mode options are Sub-stream, HDD (Main Stream), Alarms (HDD) and None. By default, sub-stream is chosen. Turn this option to **NONE** when an SD card is not present in the unit. SD card data includes frame information only. Once you have chosen the record mode, tick which channel you would like to record to the SD card.

The sub-stream option enables you to customise audio function, set resolution, frame rate and quality. Easily copy to all channels with the Copy To button.

HDD (Main Stream) mode will mirror record HDD settings onto SD card.

Alarms (HDD) only the alarms will be recorded onto the SD card.

Note: When SD cards/HDDs are replaced, it must be formatted using an MDR prior to use.

Sub-Stream CH by default enables all available channels. If the IP camera dedicated channels have not been enabled in **IPC Setup** (explained in chapter 7.2.3 IP Camera Setup), the channel box is grey-out and unable to operate.

Setup allows you to configure the functions below for each SD card channel. See *SD Setup Figure 80*. All the functions below are related to the Sub-stream option. These do not apply to HDD (Main Stream) or Alarms (HDD).

Enable this controls which channels you would like to sub-stream video and save to the SD card. When using a MDR 504, channel 5 and 6 is not accessible and grey-out (channel 9 – 16 for MDR 508) until they been enabled in IP Setup. See *IPC Setup Figure 82*.

Audio activation allows users to enable/disable the audio recording from the camera channels individually. This setting depends on the utilised cameras having microphones.

Resolution can be setup per channel. Options are: QCIF, CIF, HD1, D1, AHD (720p and 1080p). These options are dependent on input to MDR.

Frame Rate allows users to choose different frame rates for different channels depending on resolution settings. Options are 1 to 25 for PAL and 1 to 30 for NTSC.

Quality has 8 levels. Level 1 is the best quality whereas level 8 is the lowest quality. Brigade recommends using a higher quality for Alarms for a higher level of image detail.

Copy to function is available to copy settings to all or individual channels.



SD Figure 79



SD Setup Figure 80

7.2.2.4 Record OSD

Record OSD refers to information that will be “burned” onto the video image directly. This means that if AVI is used for the export option, then the enabled information will be shown on the image.

The options are: Date/Time, Vehicle Reg, Channel Name, G-Force, Speed, GPS, Vehicle Num and Alarms.

You can change the position of each live OSD by using the **Setup** button.

By default, DATE/TIME, VEHICLE REG, CHANNEL NAME, SPEED and ALARMS are enabled.



Record OSD Figure 81

7.2.3 IP Camera Setup

To connect Internet Protocol Cameras (IPCs) to this MDR, a Power Over Ethernet (PON) switch or Brigade IP-1XXXX cable is required.

This allows 2 IP cameras to be connected to a 4channel MDR and 16 IP cameras to an 8 channel MDR.

To enable a channel or use FAST SETUP, an IPC must already be connected.

By default, the LOCAL ADDRESS for MDR itself is 10.100.100.1.

For more IP camera setup and operation, please refer to *IP Camera Operational Guide*.



IPC Setup Figure 82

7.3 Events

7.3.1 General

7.3.1.1 IO

IO Number refers to the input sensor number. There are 8 input triggers. This will correlate to a physical wire on the MDR-IO-01 cable.

IO Description is filled in for additional information. This is usually completed by the installer to aid in identifying an input trigger in the future. Up to 8 alphanumeric characters can be used. This is an important field to be filled in, it is displayed under alarm description in the event log within MDR-Dashboard 5.0 software.

Alarm Descr	Time	Alarm Typ
Left Ind Li panel	15:27:42 - 15:28:46 15:27:07 - 15:27:29	IO 1(Li) Panic But
Right In Ri	15:29:33 - 15:29:51	IO 2(Ri)



IO Figure 83

IO ID is a 2-alphanumeric character identifier. This is an important field to be filled in as this information is then carried over to the MDR-Dashboard 5.0 software. This is shown in frame information. It is also shown on the LIVE OSD and the RECORD OSD. By default, Brigade uses IO1 for left indicator (Li), IO2 for right indicator (Ri), IO3 for reverse (Rv) and IO4 for brake (Br). The IO wires have a priority with OI1 being the highest and IO8 the lowest.



It is possible to duplicate the field information to all 8 input triggers, but this is not advised as each trigger will be connected to varied sources.

7.3.1.2 Peripherals *Please see 2.2 Optional Accessories for part numbers*

Remote Panel is an accessory that consists of 4 diagnostic LEDs and a panic button. In a scenario where the MDR is installed in a box away from the driver or the MDR output is not being viewed, the remote panel LEDs will alert the driver to any hardware or software faults. By default, this is off.

The panic button can be used for varied scenarios. For example, when using a mobile network/Wi-Fi MDR, this button can be used to trigger real-time emails to the fleet manager.

G-Sensor is enabled if there is an external G-sensor being used. This is optional. By default, this is off.



Peripherals Figure 72a Remote Panel and G-Sensor



Peripherals Figure 84

7.3.1.3 Speed

Unit refers to the speed setting. This can either be in miles per hour (MPH) or kilometres per hour (KM/H). By default, this is set to MPH.

Source has two options. GPS or Speed Pulse. In majority of applications GPS signal is the simplest to use. Brigade's MDR comes as standard equipped with a GPS antenna.

Speed source from the vehicle is recommended when the GPS signal is absent or poor (e.g. mines or major city centres). The vehicle speed signal may be a more reliable source. By default, GPS is the source used.



Speed Figure 85

Speed Pulse - Calibration Mode has two options, Input Manually and Auto Correct. Auto Correct is currently unused.

To use input manually, connect the speed cables on the IO cable then click save. Start the vehicle and then click start. Drive for at least a minute with a minimum speed of 40 km/h or 25 mph. Once you have stopped the vehicle, click the finish button. Now, you will have a mileage value (from your drive). Input the mileage value into the box and click calculate. Finally, your pulse ratio has been calculated. The pulse ratio will not change without speed pulse data input. (This section can only be viewed by selecting "Speed Pulse" in the Source dropdown box).

Start is used to begin the analysis of your drive.

Calculate is used to obtain the pulse ratio once you have entered the mileage value.

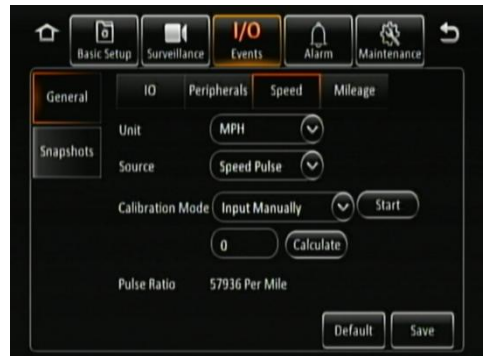

Speed Pulse Figure 86

7.3.1.4 Mileage

Total Mileage displays the total mileage of the vehicle once it has been confirmed in mileage setup. The speed unit controls whether this value is displayed in miles or kilometres.

Actual Mileage is a field that is manually entered. Type the current value mileage value once the MDR is installed.

Mileage Setup is used to submit the mileage value to the MDR memory, click confirm once you are happy with the value. Click clear to zero the total mileage value. Prompts will display to ask for user confirmation.



Mileage Figure 87

7.3.2 Snapshots

Snapshot refers to an image of the video data displayed on an MDR channel.

7.3.2.1 Time Snap

Time Snap must be ticked to enable all the options. You can have a maximum of 8 snap entries. By default, time snaps are disabled.

Delete removes a time snap entry. You cannot delete entry 1.

Snap Link Setup is where your time snap is setup.

Start time refers to the time you would like time snaps to start.

End time refers to the time you would like time snaps to end.

There is no limitation of the number of snaps, but this uses the same storage limit as recordings. If the storage is full, then the oldest snap will be written over. Snaps are stored by vehicle registrations and time.

When exporting snaps to a USB flash drive. A folder named picture found in the following path F:\MDR-504xx-xxxx\vehicle registration\date\picture will be created.



Time Snap Figure 88

Channel is the channel that would like to setup a time snap for.

Snap Enable controls whether time snaps are enabled for that channel. To activate the other menu options, snap enabled must be ticked.

Resolution refers to the time snap resolution. The options are: CIF, WCIF, HD1, WHD1, D1, WD1 and AHD (720p and 1080p). This is dependent on the input resolution of the cameras connected to the MDR.

Quality represents the image quality of the snapshot. There are 8 levels. Level 1 is the best quality whereas level 8 is the lowest quality. By default, this is 1.

Snap Count refers to how many snaps will be taken. A maximum of 3 snaps can be taken for a minimum of 5 seconds. By default, this is 1.

Snap Interval is the period between each snap which can be between 5 and 3600 seconds. By default, this is 5 seconds.

7.3.2.2 IO Snap

Alarm Snap Link Setup are used for taking snaps based on triggered alarms only.

Mobile App / Web Snap Link Setup is unused currently.



Snap Link Setup Figure 89



IO Snap Figure 90

7.4 Alarms

7.4.1 General

There are various alarms that can be configured in the MDR. Such as speed, panic, IO, video loss, motion detection, blind detection, G-Force, Geo-Fencing and HDD/SD Error. Alarms and events are different. Alarms are reported to the Centre Server (depending on MDR model). Events are stored but do not get reported to the Centre Server. (Please click into the Alarm Link before the following function can be viewed. See Speed Alarm Figure 93). **All alarms use the Alarm Link Setup page. (See Alarm Link Setup 1 Figure 91)**

Channel is used to choose which channels you would like the alarms to be triggered based on. The options are 1 to 6 (4CH) and 1 to 16 (8CH).

Post Record specifies the period of recording appended at the end of an alarm. For instance, if a sensor is triggered for 1 sec and the alarm duration is 30 seconds and the post recording is 15 seconds, the total amount of recording time will be 45 seconds. By default, this is 10 minutes.

Lock represents whether an alarm cannot be overwritten by the MDR. When the retention expires, the locked files will automatically be unlocked and deleted. Refer to *Chapter 7.2.2.1 General* on how to set lock expiry timeframes.

Alarm Output Link refers to the 2 outputs found on the IO cable. These outputs can be activated based on a linked alarm. Enable this for a high on the alarm outputs.

Alarm Output Duration represents the amount of time the alarm output will be active for. This can be between 0 and 255 seconds.

Channel Link can be used to display a single or quad configuration.

Panic Button Alarm Duration is active when an external remote panel is connected to the IO cable. This will sound the remote panel's buzzer for the specified time. By default, this is 0 seconds. The options are 0 to 255 seconds.

Buzzer refers to the built-in buzzer inside the MDR docking station. Once this is enabled the duration can be configured.

Buzzer Duration can be configured in two ways depending on the type of alarm being triggered. The options are ALWAYS (the buzzer will sound continuously without interruption) or TIMER (the buzzer will sound for the defined period). Timer can be set between 5 and 60 seconds. For example, video loss is a catastrophic failure and Brigade suggests using ALWAYS for such an alarm.

Alarm Snap can be enabled, the settings are based on the alarm snap link setup. Refer to 7.3.2 Snapshots to define what a snapshot is.

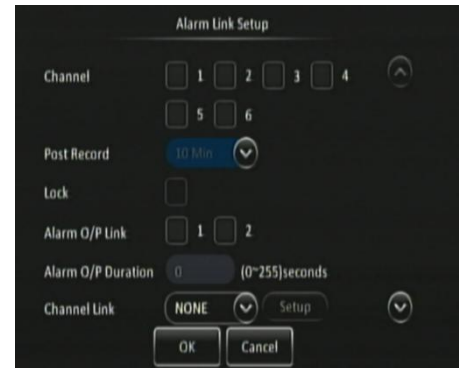

Alarm Link Setup 1 Figure 91

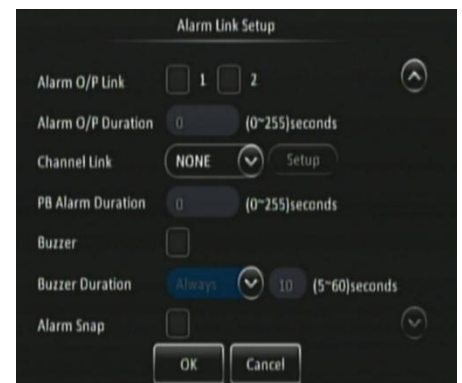

Alarm Link Setup 2 Figure 92

7.4.1.1 Speed Alarm

Overspeed Enable is used to activate overspeed alarms or events.

Alarm Type can either be alarm or event. Alarms are saved to the Centre Server (depending on MDR model, requires 4G/Wi-Fi) and are displayed in the alarm log in Live view in MDR-Dashboard 5.0 Server mode.

Events are stored but do not get saved to the Centre Server. Events are not displayed in the live view alarm log.

Trigger Setup is used to control the conditions for the trigger. (See *Speed Trigger Figure 94*)

For Alarm Link Setup details refer to 7.4.1 General.

Early Difference is an early warning for drivers to curb their speed. For example, if you set the speed to 70mph, and early difference is set to 5mph, then when your speed reaches 65mph, the MDR will sound a short beep to warn the driver. By default, early difference is set to 10 mph.

Speed refers to threshold value for which speed will be considered an overspeed and recorded as an alarm.

Duration Time specifies different lengths of time which allow for longer/shorter alarm durations. If the alarm duration is set to 30 seconds and a short 2 seconds alarm occurs, this would be treated as a 30 second alarm. Can be set between 0 to 255 seconds. By default, the duration time is 10 seconds.

Alarm Off-Delay is a period in which rapid activations/deactivations can occur, which must be ignored. This is applied when indicators or hazard lights are connected to an input trigger where the off-time is ignored. By default, this is 10 seconds.



Speed Alarm Figure 93

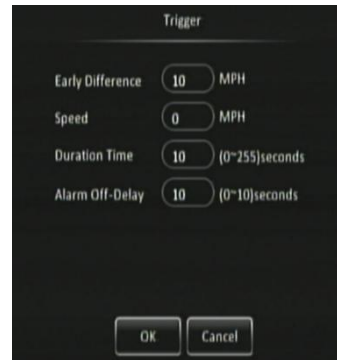

Speed Trigger Figure 94

7.4.1.2 Panic Alarm

Panic Button Enable refers to the panic button found on the external remote panel. This is connected to the MDR via the IO cable. By default, this alarm is enabled. Refer to *Panic Alarm Figure 95*

Alarm Type can either be alarm or event. Alarms are reported to the Centre Server (depending on MDR model). Events are stored but do not get reported to the Centre Server.

For Alarm Link Setup details refer to 7.4.1 General. Clicking Trigger Setup will display *Panic Trigger Figure 96*.

Activation Period refers to how long the panic button needs to be pressed for, to be considered an alarm (high). By default, this is 1 second.

Alarm Off-Delay is a period in which rapid activations/deactivations can occur, which must be ignored. By default, this is 10 seconds.



Panic Alarm Figure 95

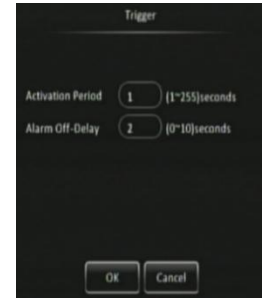

Panic Trigger Figure 96

7.4.1.3 IO Alarm

IO Enable allows users to set which trigger input wires are used. If a wire is not used, set enable to off. IO1 has the highest priority and IO8 has the lowest.

Alarm Type can either be alarm or event. Alarms are reported to the Centre Server (depending on MDR model). Events are stored but do not get reported to the Centre Server.

For Alarm Link Setup details refer to 7.4.1 General.

IO Set is a field that controls whether an input trigger will trigger on a low or high signal. Determines whether the trigger sensor is activated with a high or low voltage.

Copy please refer to Section 7.2 Surveillance for details.



IO Alarm Figure 97

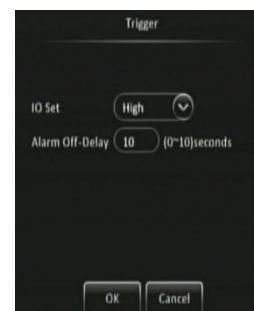

IO Trigger Figure 98

Alarm Off-Delay is a period in which rapid activations/deactivations can occur, which must be ignored.

7.4.2 Video

7.4.2.1 Video Loss

Video Loss Enable is used to alert you to a loss of video signal on any of the enabled camera input channels. By default, this is enabled.

Alarm Type can either be alarm or event. Alarms are reported to the Centre Server (depending on MDR model). Events are stored but do not get reported to the Centre Server.

For Alarm Link Setup details refer to 7.4.1 General.

Channel is used to choose which channels you would like the alarms to be triggered from. The options are 1 to 6 (4CH) and 1 to 16 (8CH). All channels ticked by default.

Alarm Off-Delay is a period in which rapid activations/deactivations can occur, which must be ignored. By default, this is 10 seconds.



Video Loss Alarm Figure 99

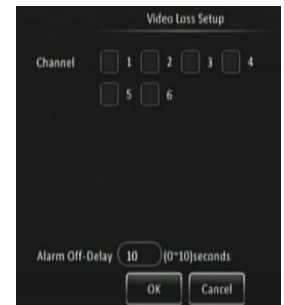

Video Loss Setup Figure 100

7.4.2.2 Motion Detection

Motion Detection Enable is used to analyse camera inputs for motion. By default, this is disabled.

Alarm Type can either be alarm or event. Alarms are reported to the Centre Server (depending on MDR model). Events are stored but do not get reported to the Centre Server.

For Alarm Link Setup details refer to 7.4.1 General.

Channel is used to choose which channels you would like the alarms to be triggered from. The options are 1 to 6 (4CH) and 1 to 16 (8CH).

Sensitivity each channel can have different sensitivities and different areas of detection. 1 represents most sensitive and 8 is the least sensitive.

Area Setup lets you choose the area of interest in the camera image. Green blocks are areas where motion will be detected. Using the mouse, drag and drop a yellow square to deactivate areas that you want to be ignored. To reactivate the area, use the mouse to drag and drop over the deactivated area.

Activated determines when motion detection will be active. The two options are Shutdown Delay or Ignition On. Shutdown delay means that motion detection will only be active once the ignition has been turned off, the period depends on the general shutdown delay. Ignition on means that motion detection will be active whenever the MDR has ignition applied.

Alarm Off-Delay is a period in which rapid activations/deactivations can occur, which must be ignored. By default, this is 10 seconds.



Motion Detection Alarm Figure 101



Motion Detection Setup Figure 102



Area Setup 1 Figure 103

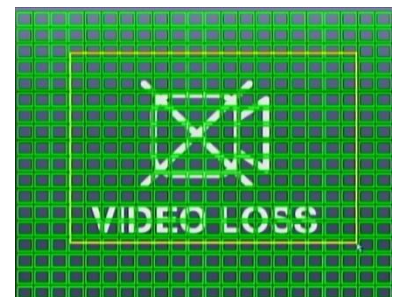

Area Setup 2 Figure 104



Area Setup 3 Figure 105

7.4.2.3 Blind Detection

Blind Detection Enable is used to analyse camera inputs for blind images. By default, this is disabled. Blind detection occurs when a camera is obstructed by a large object or deliberately. It is mostly used to tackle acts of vandalism.

Note: Blind detection is not recommended when using cameras with infrared illumination.

Alarm Type can either be alarm or event. Alarms are reported to the Centre Server (depending on MDR model). Events are stored but do not get reported to the Centre Server.

For Alarm Link Setup details refer to 7.4.1 General.

Channel is used to choose which channels you would like the alarms to be triggered from. The options are 1 to 6 (4CH) and 1 to 16 (8CH).

Sensitivity has three options; High, Middle and Low.

Duration Time specifies different lengths of time which allow for longer/shorter alarm durations. If the alarm duration is set to 30 seconds and a short 2 seconds alarm occurs, this would be treated as a 30 second alarm. Can be set between 0 to 255 seconds. By default, this is 5 seconds.

Delay Time refers to how long the blind image must be detected for. This is to avoid false alarms. By default, this is set to 5 seconds. Can be set between 0 to 255 seconds.

Alarm Off-Delay is a period in which rapid activations/deactivations can occur, which must be ignored. By default, this is 10 seconds.



Blind Detection Alarm Figure 106

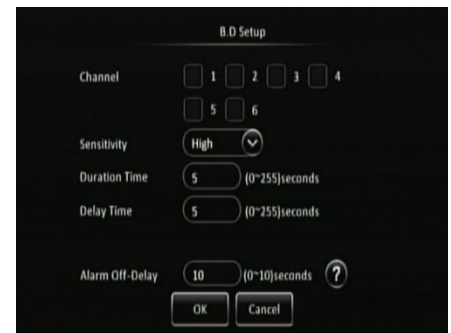

Blind Detection Setup Figure 107

7.4.3 Advanced

7.4.3.1 G-Force

G-Force Enable is used to analyse the MDR's g-force values. By default, this is disabled.

Alarm Type can either be alarm or event. Alarms are reported to the Centre Server (depending on MDR model). Events are stored but do not get reported to the Centre Server.

For Alarm Link Setup details refer to 7.4.1 General.

Calibrate internal or external G-sensor requires calibration before use. Once the unit is installed (on level horizontal ground) with the vehicle stationary (no vibrations/engine off) click the calibrate button. This will zero all three axes: X, Y and Z. Travelling forward with the MDR handle indicating the front and the connectors on the back indicating the rear; Y represents left/right; Z represents up/down.

Threshold Value refers to the G values for which it will be considered an alarm. This must be tested and determined for your specific vehicle.

Alarm Off-Delay is a period in which rapid activations/deactivations can occur, which must be ignored. By default, this is 10 seconds.

Note: G-Sensor values are digitally sampled and only provide an average indication of the shock data.



G-Force Alarm Figure 108

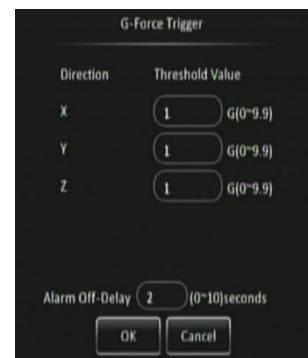

G-Force Trigger Figure 109

7.4.3.2 Geo-Fence

Geo-Fence Enable is used for mobile network MDR models. It must be enabled prior to using this feature.

Geo-fences are used to send an alarm if a vehicle leaves or enters a geographical region. This region is setup by the user in MDR-Dashboard 5.0.

Geo-fences are setup in MDR-Dashboard 5.0 Server mode. Please refer to the Network Connectivity SW & Infrastructure Manual.

In **Geo-Fence Alarm** Link Setup, it supports a **Non-stop** feature for IO output. If Non-stop enabled, The Alarm O/P duration will be greyed-out. This allows the MDR to keep a continuous high-level output as long as it is in the Geo-Fence area.

Note: Please make sure either, Alarm O/P Link 1 or 2 is enabled before ticking the Non-stop box. If Non-stop box is ticked without allocating any O/P Link, there will be no output.



Geo-Fencing Alarm Figure 110

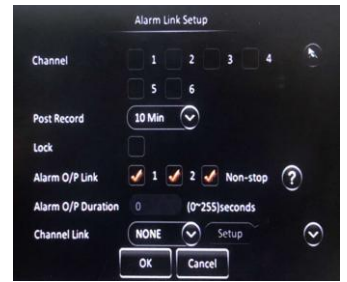

Non-Stop Feature Figure 111

7.4.3.3 HDD/SD Error

HDD/SD Error Enable is an alarm which indicates when the HDD/SD has a major malfunction where data can no longer be written to the storage medium.

Alarm Type can either be alarm or event. Alarms are reported to the Centre Server (depending on MDR model). Events are stored but do not get reported to the Centre Server.

For Alarm Link Setup details refer to 7.4.1 General.

Alarm Off-Delay is a period in which rapid activations/deactivations can occur, which must be ignored. By default, this is 10 seconds.



HDD Error Alarm Figure 112

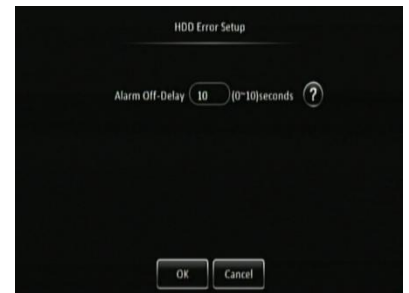

HDD Error Setup Figure 113

7.5 Maintenance

A bus-powered USB hub (minimum of 2 USB ports for USB mouse and USB flash drive) will be required to export/import configuration, network files and geo-fence files. Please note Config Files are created by the user.

7.5.1 Configuration

7.5.1.1 Config File

Config File Export creates a configuration file and saves this to a USB flash drive. This file includes all settings except network and geo-fence related settings. This file can only be read by an MDR 500 Series model. This is channel dependent.

A configuration file named CONFIG.CONFIG will be created on the root of the USB flash drive.

Warning: Network settings and Register Info settings are not contained in a configuration file. To support MDR fleet setups with an identical configuration file.

Note: If a configuration file with the same name is present, this will be overwritten.

Config File Import is used when you have an existing configuration file on your flash drive and wish to import those settings to the MDR.



MDR504 Series Configuration File Figure 114

For MDR-508 series only:

Import Ethernet HTTPS Certificate and Key is used to import a new encryption key and certificate when the built-in ones have expired.

For importing, place the new key and certificate file in a folder named **webcert** under the root directory of the flash drive. Rename the certificate file as **webserver_cret.pem** and the key file to **webserver_key.pem**. Click **Import** to load both files into the MDR. And the folder structure should be as below:

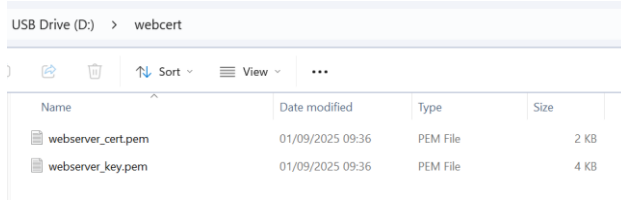

MDR-508 Ethernet HTTPS Certificate and Key Files USB Drive Folder Figure 115

Note: the MDR is equipped with a default HTTPS certificate valid for 10 years. In most cases this operation is not required.

Remove Ethernet HTTPS Certificate and Key is used to remove the existing HTTPS certificate and key in the MDR.

Import SMACON TLS Certificate and Key is used to import a new encryption key and certificate for SmartController communication when the built-in ones have expired.

For importing, place the new key and certificate file in a folder named **appcert** under the root directory of the flash drive. Rename the certificate file as **app_cret.pem** and the key file to **app_key.pem**. Click **Import** to load both files into the MDR. And the folder structure should be as below:

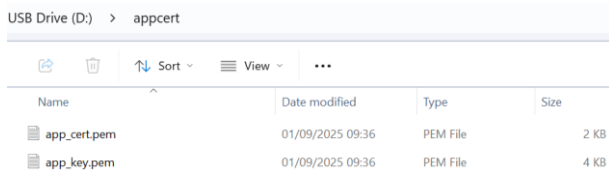

MDR-508 SMACON TLS Certificate and Key Files USB Drive Folder Figure 116

Note: the MDR is equipped with a default TLS certificate valid for 10 years. In most cases this operation is not required.

Remove SMACON TLS Certificate and Key is used to remove the existing TLS certificate and key in the MDR.

7.5.1.2 Network File

Network File Export creates a file that contains all network related settings, such as: server, ethernet, mobile network and wi-fi settings. This will be called NETWORK.CONFIG.

Network File Import is used when you have an existing network file on your flash drive and wish to import network settings to the MDR.



MDR508 Series Configuration File 1 Figure 117

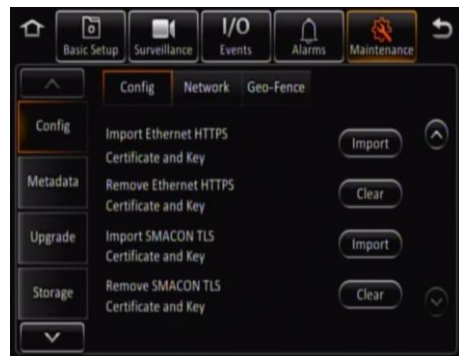

MDR508 Series Configuration File 2 Figure 118



Network File Figure 119

7.5.1.3 Geo-Fence File

Geo-Fence File Export creates a file that contains geo-fence parameters. This file will be called GEO-FENCE.CONFIG.

Geo-Fence File Import is used when you have an existing network file on your flash drive and wish to import geo-fence settings to the MDR.



Geo-Fence File Figure 120

7.5.2 Metadata

Information related to recording parameters, alarms and trigger status can be recorded along with speed, location and G-Force data. In addition, data related to the unit itself such as voltage and temperature are recorded and plotted graphically in MDR Software (MDR-Dashboard 5.0 and MDR-Player 5.0). This information is called metadata.

7.5.2.1 Data Export

This area is used to export data to a USB Flash drive.

All will export all historical data for the chosen file type that the MDR has stored.

Export Time lets you choose a specific period which may be of interest. You can specify the date and time.

File Type allows you to choose the metadata that you would like to export. The options are: Snapshots, GPS Data, G-Force Info, Mob Net Dial Log, Alarm Log and Operation Log.

The storage location follows the format \\MDR unique serial number\MDR-504GW\YYYY-MM-DD\log\log type and can be read using Notepad™.



Data Export Figure 121

7.5.3 Upgrade

A bus-powered USB hub (minimum of 2 USB ports for USB mouse and USB flash drive) will be required for upgrade procedures.

FMW/MCU Upgrade is used to upgrade firmware and MCU (Microcontroller) version. Firmware contains MCU version (combined package) for an easier upgrade. Although, you can also do individual firmware and MCU version upgrades if there have been newer versions released with new features. Please check Brigade's website regularly for updates. Upgrades require a USB bus-powered hub. Firmware upgrades take approximately 5 minutes to upload. Firmware is OSD (on-screen display) related software and directly affects the user interface.

MCU version is software related to MDR hardware functions.

Create a folder named **upgrade** in the root directory of your USB flash drive. Copy either the MCU version or firmware files (or the combined package). Plug the USB flash drive into USB bus-powered hub which is then connected to the front of the MDR. Click upgrade to start the upgrade process, see *Upgrading Progress Figure 123*. After the upgrade, the MDR will restart and display *System Upgrade Figure 124*. Check if the firmware/MCU version has been upgraded successfully by checking system information.

Automatic upgrades can also be carried out. To complete this type of upgrade, create a folder named **autoupgrade** in the root directory of your USB flash drive. Plug the USB flash drive into USB bus-powered hub which is then connected to the front of the MDR. The process will only begin once the MDR boots up after ignition or after a manual restart. The MDR will look for the folder during the start-up period. If it does see a different firmware, then you will be shown *Autoupgrade Figure 125*. If the firmware version is the same version installed on the MDR then no upgrade will occur.

Warning: Do not connect an external HDD to the front USB port. Only USB Flash drives (which contain flash memory) is supported by this port. Brigade will not be held responsible for incorrect use of this port.

Warning: Ensure the flash drive is not unplugged from the MDR during this process. Power must be supplied to the MDR without any interruption. Both firmware and MCU upgrades are very sensitive operations and any power loss may permanently damage the MDR.

IPC Upgrade refers to IP camera upgrades. Refer to IP Camera Operational Guide.



Upgrade Figure 122

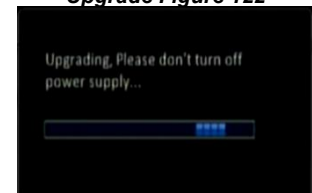

Upgrading Progress Figure 123

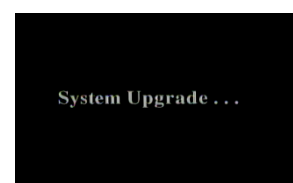

System Upgrade Figure 124



Autoupgrade Figure 125

7.5.4 Storage

Format is used to remove data from the different storage types. It is possible to format HDD, SD (Internal), SD (Fireproof Box) and Front USB. You will be asked to confirm if you would like to format prior to the MDR starting the format process. See below.

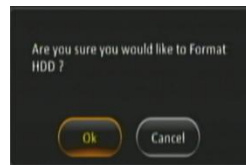

To format the fireproof box, click format then choose MDR5. This will format the device into a proprietary format that the MDR can record to.

A USB flash drive that is plugged into the front USB of the MDR can also be formatted to MDR5 or FAT32 format. After formatting the HDD, the MDR will restart automatically.

Warning: Formatting the different storage types will delete all the data from that storage.

Note: SD (Fireproof Box) and Front USB will only be shown on the OSD if plugged in



Storage Figure 126

7.5.5 Reset

Factory Settings Restore use this feature to restore the configuration to its default factory settings. Any configuration will be lost, except video recordings and historical data (highest/lowest temperature, mileage etc.).

System Restart is used to force the MDR to restart.



Reset Figure 127

7.5.6 Hardware

Hardware Config Import is used to import a hardware config file from a USB Flash drive. Ensure that you have copied the entire folder "HWConfigFile" to your flashdrive. If the folder path has been changed, this will not work and will not find the file correctly. See *Hardware Config Import Figure 135* for a successful prompt window after an import

Hardware Config Export is used to export hardware configs to a USB flash drive. These can be used on other MDRs that will have the exact setup. This is a quick method to check the hardware installation. If a hardware config is imported to an MDR, there is no need to login (super system check). Click Export to create hardware config file. See *Hardware Config File Figure 134* for the typical path that is automatically created.

General System Check requires the vehicle registration to be filled in prior to checking. You must have an existing hardware config file on the MCU. It is used to check for faults.

Super System Check is used to create a hardware configuration file. Click Login. By default, the Super User password is blank. You are required to create a password, see *Super User Password*

Figure 129. We recommend changing the password to "admin". You will then be presented with the hardware check screen. This indicates the state of the HDD, SD cards, cameras and modules. Click the Create button to store a hardware config on the MCU. See *Hardware Config Save Figure 132.*



Hardware Figure 128

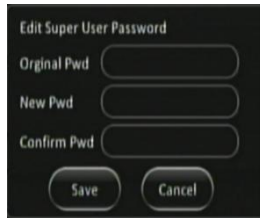

Super User Password
Figure 129

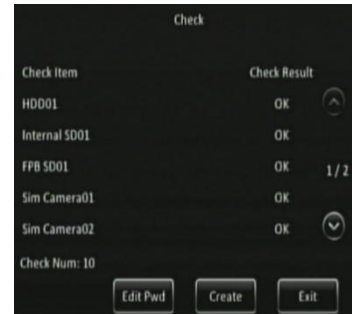

Hardware Check Page 1 Figure 130



Hardware Check Page 2 Figure 131



Hardware Config Save Figure 132



Hardware Config Export Figure 133

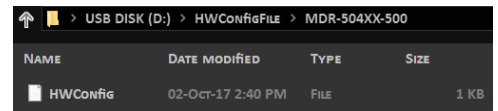

Hardware Config File Figure 134

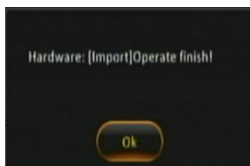

Hardware Config Import Figure 135



General System Check Figure 136

7.5.7 Certificate

All files imported here are for supporting Verify Certificate feature, for detailed functionality, please refer to Chapter 7.1.6.5 Server.

Trusted Root Certificate Users shall obtain the root certificate from a Certificate Authority (CA) and place it in a folder named **cers** in the root directory of the flash drive. Press the **Import** button to load the file into the MDR.

Note: A maximum of hundreds root certificates can be imported. The file name must not exceed 64 characters in length.

Remove ALL Root Certificate is used to remove all the existing root certificates in the MDR.

Certificate Revocation Lists (CRLs) is used to check whether the server's HTTPS certificate has been revoked or is no longer valid. For importing, place the latest CRL files in a folder named **crls** in the root directory of the flash drive. Press the **Import** button to load files into the MDR.

Note: The maximum file size supported for import is 2048KB. The file name must not exceed 64 characters in length.

Remove CRLs is used to remove all the existing CRLs in the MDR.



Certificate Figure 137

8 System Information

8.1 Version Information

Device Name is a pre-populated field to help identify the MDR unit. The two available options that will be displayed is either MDR-504XX-XXXX or MDR-508XX-XXXX.

Serial Number is a unique identifier for each MDR unit. This information is used to connect a mobile network or Wi-Fi MDR to MDR-Dashboard. This is made up of 10 alphanumeric characters.

MAC Address refers to media access control address which is a unique identifier. This is assigned to network interfaces for communications at the data link layer of a network segment. This consists of 12 alphanumeric characters.

Firmware Version refers to the firmware which contains the OSD menu. The structure follows: MDR-504_VXXX_TXXXXXXX.XX or MDR-508_VXXX_TXXXXXXX.XX.

MCU Version refers to microcontroller firmware which is installed in the MDR unit. This firmware controls all hardware operations. Such as the HDD heater. This is made up of 9 alphanumeric characters.



Version Information Figure 138

8.2 Modules

8.2.1 Mobile Network

This tab will only show if enabled and configured.

Connection Type shows the connection used to connect to network operators. The options are: GPRS/EDGE, CDMA, EVDO, WCDMA, TDSCDMA, FDD and TDD.

Module Status shows whether the MDR sees the presence of the mobile network module. This will say detected or not detected.

SIM Status shows whether the MDR sees the presence of a SIM card. The statuses are detected, not detected, available, not available and busy.

Dial Status indicates the SIM's dial status, which can be dialled up, failed dial up and unknown error.

Signal Level will display the power level of the signal, this will be xxdBm format.

IP Address refers to the IP address obtained by the SIM from the network provider.

IMEI refers to International Mobile Equipment Identity number. This is made up of 15 alphanumeric characters.

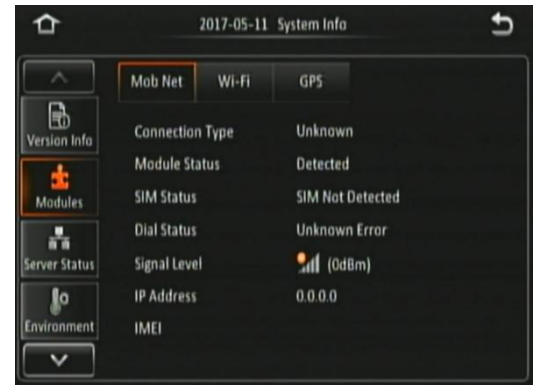

Mobile Network Figure 139

8.2.2 Wi-Fi

This tab will only show if enabled and configured.

Built-in Wi-Fi Status indicates the current physical state of the internal Wi-Fi module. This can be detected, not detected, connecting, connection failed, connected and obtaining IP address (DHCP).

Signal Level will display the power level of the signal in a visual form . The more blue bars the better the signal level.

IP Address refers to the IP address obtained by the wireless module.

MAC Address refers to media access control address which is a unique identifier. This is assigned to network interfaces for communications at the data link layer of a network segment. This consists of 12 alphanumeric characters.

SmrtCntrlr Wi-Fi Status is unused currently.

SmrtCntrlr SSID is unused currently.

SmrtCntrlr IP Address is unused currently.

SmrtCntrlr MAC Address is unused currently.



Wi-Fi Figure 140

8.2.3 GPS

GPS Status shows whether the MDR sees the presence of the GPS module. This will say detected or not detected.

GPS Satellite Count shows how many satellites the GPS module sees, the value can be between 1 and 24.

Speed indicates the current speed of the vehicle.



GPS Figure 141

8.3 Server Status

Centre Server # displays the current server configuration details. A maximum of 6 centre servers can be stored.

Server Status shows connection state of the chosen server. This can either be connected or unconnected.

Network Type indicates the type of connection interface the centre server will use to attempt to communicate with the MDR Server. There are three options: Ethernet, Wi-Fi and mobile network.

Server protocol type shows the built-in proprietary communication protocol that will be used between the MDR unit and MDR Server. This can either be MDR5 or maintenance. Ensure that this is set to MDR5.

Server IP Address displays the IP address of the MDR Server. This can either be internal or external IP address.

Port shows the port used for communication between the MDR and MDR server.

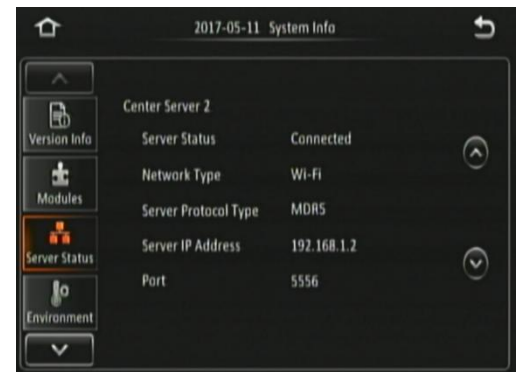

Server Status Figure 142

8.4 Environment

Voltage (V) indicates the current voltage level the MDR is receiving.

Device Temperature (°C) shows the physical temperature of the MDR unit.

HDD Heater Status indicates the current state of the heater. The heater is found on the HDD inside the MCU. The heater turns on automatically once the environment temperature reaches 0°C.

Note: The MDR will not recording while MDR warming up, until it reaches 5 °C and turn on properly.

Ignition Status indicates the current state of the ignition wire – yellow on MDR power cable.



Environment Figure 143

8.5 Storage

Storage Type refers to the medium of storage. By default, HDD and SD (Internal) should be displayed. FRONT USB may also be displayed here if a flash drive is connected to the front USB port, found on the docking station.

Warning: Do not connect an external HDD to the front USB port. Only USB Flash drives (which contain flash memory) is supported by this port. Brigade will not be held responsible for incorrect use of this port.

Status is an indication of the state of the storage medium. There are three states that can be shown: RECORDING, NORMAL or FAILED. Recording refers to when the medium is currently being recorded on. Normal is when the medium is not currently being recorded on but it has no errors/failures. If a state of failed is displayed, the MDR should be restarted and the storage medium formatted or replaced.

Free/Total shows the capacity of the storage media. In all storage media, once formatted, some space will be lost due to binary math. In general, for each gigabyte, you'll have about 70MB less space.

Remain Time shows the remaining time on each storage media that is currently being recorded on.

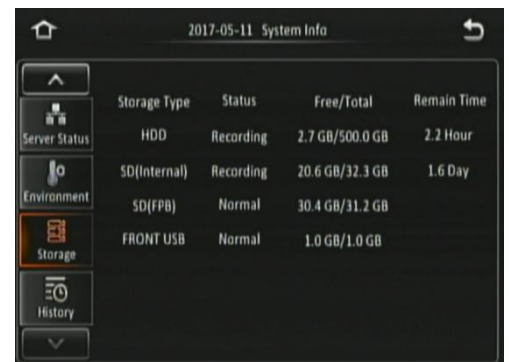

Storage Figure 144

8.6 History

Highest Speed is displayed with the relevant date and time.

Total Mileage is an indication of the vehicle's mileage.

Lowest Voltage is displayed with the relevant date and time.

Highest Voltage is displayed with the relevant date and time.

Lowest Temperature is displayed with the relevant date and time.

Highest Temperature is displayed with the relevant date and time.

Highest Information Clean is used to clear all historic information shown on this page.



History Figure 145

9 MDR-Dashboard 5.0

MDR-Dashboard 5.0 software is used for local playback, analysis, clipping, GPS tracking, vehicle information and events/log display. Remote Device and Server playback is possible with mobile network and/or Wi-Fi enabled MDR models. MDR-Dashboard 5.0 has the following features:

- Real-time Preview (Depending on model and only available in conjunction with the MDR server)
- Multi Vehicle Monitoring (Depending on model)
- Playback of Server (Depending on model) and Local Video Data
- Clipping and Downloading Data
- Evidence Management (Depending on model)
- Auto Download Scheduling (Depending on model)
- Basic Data Management
- Alarm Centre (Depending on model)

It allows exporting video clips in three different ways:

- **STANDARD** - proprietary format (readable only by MDR-Dashboard 5.0 and MDR-Player 5.0)
- **EXPORT** - an executable file containing an embedded version of the MDR-Player 5.0
- **MP4** – industry generic video format (without metadata)

Aside from exporting features and event/log display, the MDR-Dashboard 5.0 can read directly from the MCU (Mobile Caddy Unit) or the internal SD card. These features are not available with MDR-Player 5.0.

9.1 PC System Requirements

The system requires a PC with a USB 2.0 Type-A connector, which will connect the MCU to the PC. A USB cable with USB standard type A plug to standard B plug is provided with the MDR. The MDR-Dashboard 5.0 is compatible with Microsoft™ Windows™ 7, 8.x (32-bit or 64-bit version) and 10.x operating systems.

Note: To use the maps feature, an internet connection is required.

MDR-Dashboard 5.0 minimum requirements:



COMPONENT	MINIMUM REQUIREMENTS
CPU	Intel I5-6400 and above (4 Cores / 4 Threads)
Free Hard Disk Drive (HDD) space	4GB
Operating System	Windows 7 SP1
Web browser	Internet Explorer 10
Graphics Card	Integrated graphics card
Software	Flash player (up to date)
Resolution	1440x900 (minimum)
RAM	8GB

9.2 Retrieving HDD Data (Quick Guide)



Open the software by right-clicking on the icon . Select Run as administrator. This will allow the software to read information from the MCU. The default username: admin and "default password": LEAVE BLANK. Once users have filled in username (this must be lower case) click OK.

In Local mode you have two playback options, HDD and Directory. HDD - is active when the physical MCU (Mobile Caddy Unit) is connected to your local PC.

Double-click the vehicle icon . This will display ALL calendar events. Double-click on the relevant calendar date this will display the pre-playback screen. Click on the CLIP button . Only accessible during while video is being played or paused. Click on the OK button.

The clip settings window will open. Double check start time and end time. Check the number of channels you want to download. The more channels you choose the bigger the file size.

Choose an option to download your file. Standard is for backing up/for users with the software installed. As it clips and creates video files in proprietary format (H264). Export will export the footage into an executable when playing back you do not need Dashboard software installed. We recommend this option if you are sharing this file with a third party (file must not be larger than 1.5 GB). AVI files playable by common players such as Windows Media Player (WMP™). Each channel is saved separately so unable to view all channels simultaneously. This solution is the portability of the format. The disadvantage is the lack of protection and missing metadata information. Files can be played and edited by anyone. We do not recommend this option as it is not secure. Choose the path where to save your file then click OK.

Click the download button  to view active/historic downloads. The completed tasks automatically move to the Completed tab. Right-click a

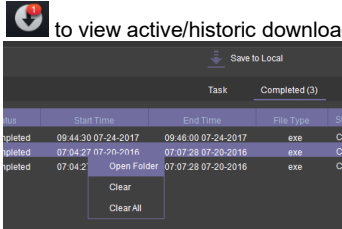

task and click open folder. This will automatically open the location of your downloaded data.

9.3 Installing MDR-Dashboard 5.0

- This operation is performed on the client PC. Right-click the installation file shown in *MDR-Dashboard 5.0 icon Figure 146* and click run as administrator.
- There may be a security warning pop-up which may be ignored. The software is verified to be virus-free. Click **RUN**.
- The setup wizard window will then be displayed. Click NEXT to begin the installation.
- Users can choose preferred language display, which is listed in *MDR-Dashboard 5.0 Setup Figure 149*. installation windows will switch to the chosen language after click OK.

Note: this only applies for installation windows, not the MDR-Dashboard 5.0 client interface. The MDR-Dashboard 5.0 client language will follow the current computer's language. If you want to change the client interface, please refer to *System Settings Figure 217*.

- Users can configure the destination location (if there is not enough free disk space) which is shown in *MDR-Dashboard 5.0 Location Figure 150*. It is NOT recommended to change the default location.
- Users can then choose if a start menu folder should be created as shown in *Start Menu MDR-Dashboard 5.0 Figure 151*.

- Referring to Desktop Icon MDR-Dashboard 5.0 Figure 152, users can choose if a desktop icon is created.
- Users are now prompted to click NEXT to begin the installation. This is indicated in *MDR-Dashboard 5.0 Installation Figure 153*.
- In *MDR-Dashboard 5.0 Launch Step Figure 154* depicts the final step, users may choose to launch the software. Tick the box and click FINISH.

 **MDR-DASHBOARD 5.0 SETUP.EXE**
MDR-Dashboard 5.0 icon Figure 146

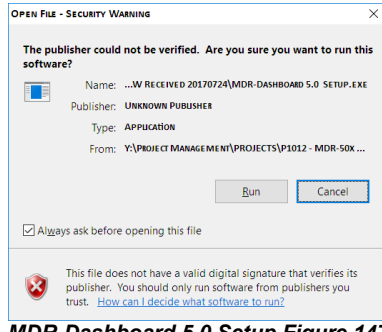

MDR-Dashboard 5.0 Setup Figure 147

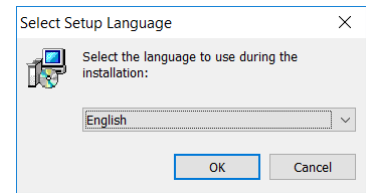

MDR-Dashboard 5.0 Setup Figure 148

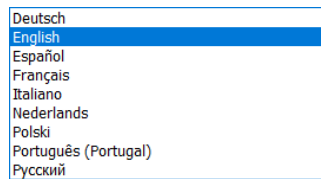

MDR-Dashboard 5.0 Setup Figure 149

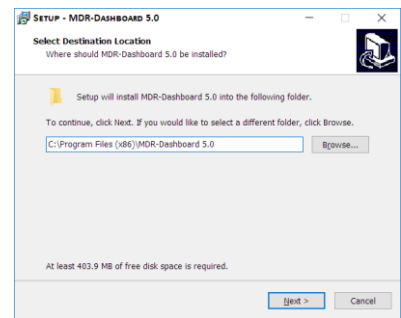

MDR-Dashboard 5.0 Location Figure 150

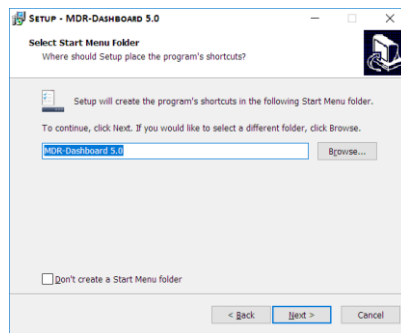

Start Menu MDR-Dashboard 5.0 Figure 151

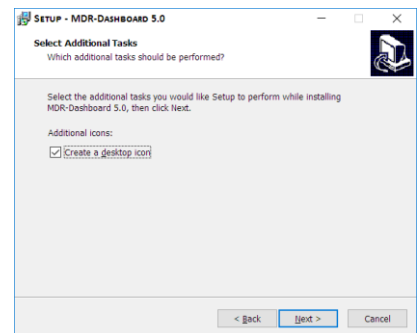

Desktop Icon MDR-Dashboard 5.0 Figure 152

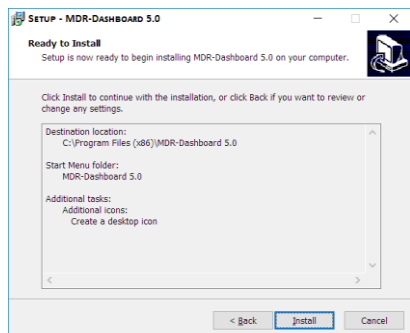

MDR-Dashboard 5.0 Installation Figure 153

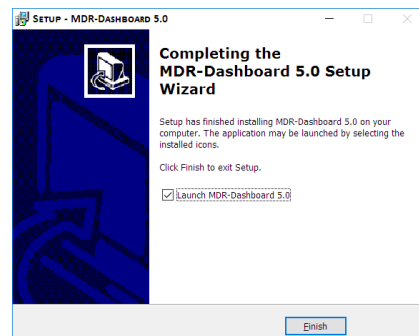

MDR-Dashboard 5.0 Launch Step Figure 154

9.4 Connecting the MCU to the PC

9.4.1 Pre-Connection Procedure (Preferred)

- Users may follow the below procedure if an internet connection is present.
- Run **Windows Update** to have the latest driver database available.
- PC must be up to date with **Windows Update**. Browse to **Control Panel** and then click on **Windows Update** to confirm this. See *Windows Update Figure 155*.

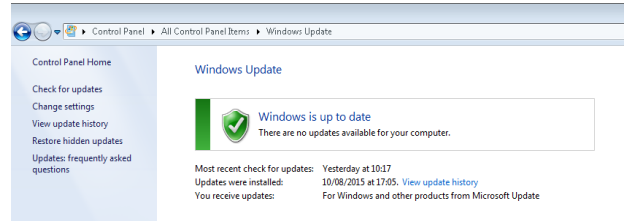

Windows Update Figure 155

9.4.2 MCU Connection Procedure (Required)

- Users must follow the procedure listed below to correctly mount the MCU to their PC.
- Connect the USB-B connector to the MCU USB port.
- Connect the USB-A (data and power) connector to a USB port on the PC. *Installing Device Driver Figure 156* will be displayed.
- Once *Device Drivers Installed Figure 157* is shown the two drivers and device have installed successfully.
- Users may now open MDR-Dashboard 5.0 and the HDD will now appear.

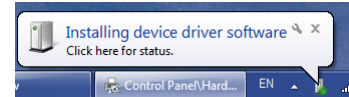

Installing Device Driver Figure 156

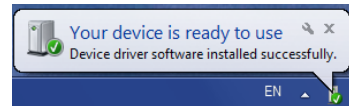

Device Drivers Installed Figure 157

Warning: Premature removal of the MCU USB-A cable from the PC (during driver installation process) will cause this process to fail. This will cause the HDD to not appear in the MDR-Dashboard 5.0.

9.4.3 Connection Confirmation

- Open Control Panel.
- Browse to Device and Printers, the device USB to ATA/ATAPI Bridge must be displayed as shown in *Devices and Printers Figure 158* as below.
- View the drivers associated with this device, right click the USB to ATA/ATAPI Bridge icon and browse to Properties.
- *General Properties Figure 159* will be presented which shows General and Hardware information.
- Two drivers must be listed under Hardware information, one that represents the USB interface and one for the HDD. See *Hardware Properties Figure 160*.

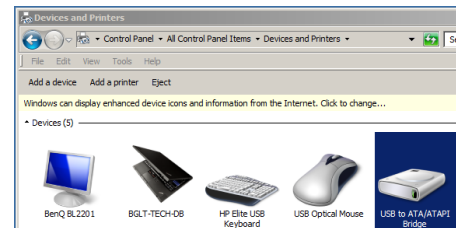

Devices and Printers Figure 158

Note: If failure occurs a manual removal of the drivers and a re-start of the PC is required. Please contact Brigade if support is needed.

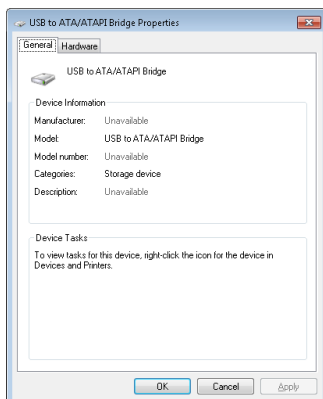

General Properties Figure 159

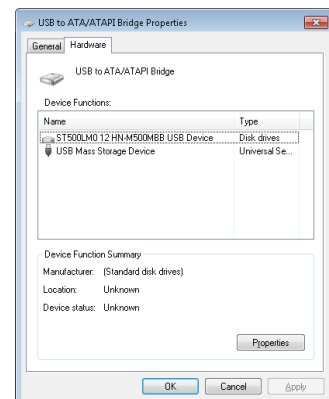

Hardware Properties Figure 160

9.5 Loading from HDD/SD

- Right-click the MDR-Dashboard 5.0 shortcut and **RUN AS ADMINISTRATOR**.
- The login screen will be displayed as shown in *Local Login Figure 161*.
- Default username: admin and there's no password, click Sign in.
- Once users have filled in the username click OK. See *Local Login Details Figure 162*.
- The software will display a loading screen as shown in *Loading Screen Figure 163*.

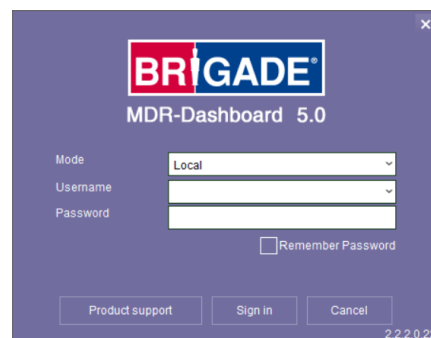

Local Login Figure 161

- This process allows users to load the content of either a connected HDD Caddy (using the USB cable) or a mirror recording from the internal/external SD Card.
- Reading these media storage devices may be slow depending on the amount of data recorded and the speed of the interface.

Note: HDD and SD cards are **not** hot pluggable, doing so may damage the HDD/SD card. To safely remove the storage medium, click on the Safe Removal icon at the bottom right of the Windows™ bar (see *Eject Figure 164* and *Cancel Format Disk Figure 165*).

Warning: After inserting SD cards into a SD card reader, Windows™ may request to format them as shown below (right). Click Cancel. Formatting SD card will delete the data from the SD card.

- To retrieve data from the HDD, connect the MCU which contains the HDD to the local PC using the USB-B cable. If the MCU does not power on then connect both USB-B cables. If MCU still does not power on, then switch to another USB port.
- Once the MCU has powered on, click the refresh icon



, the vehicle will appear as green to indicate it is available for browsing.

- The number of MCU's connected to the PC will be displayed under **HDD COUNT**. See *HDD Count Figure 166*.

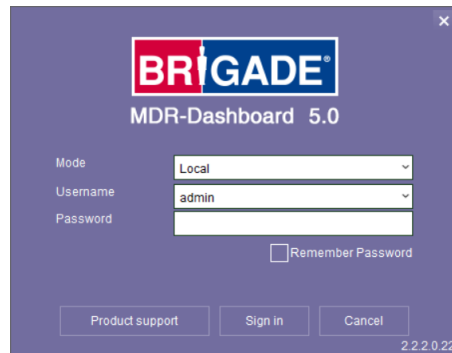

Local Login Details Figure 162

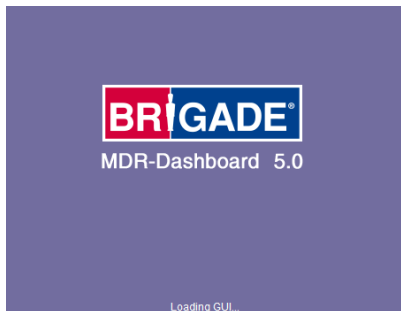

Loading Screen Figure 163

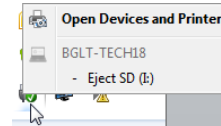

Eject Figure 164

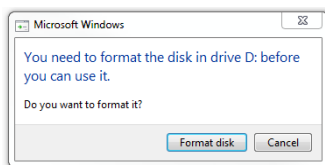

Cancel Format Disk Figure 165

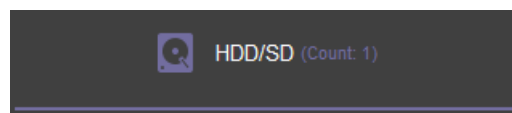

HDD Count Figure 166

9.6 MDR-Dashboard 5.0 Local Mode

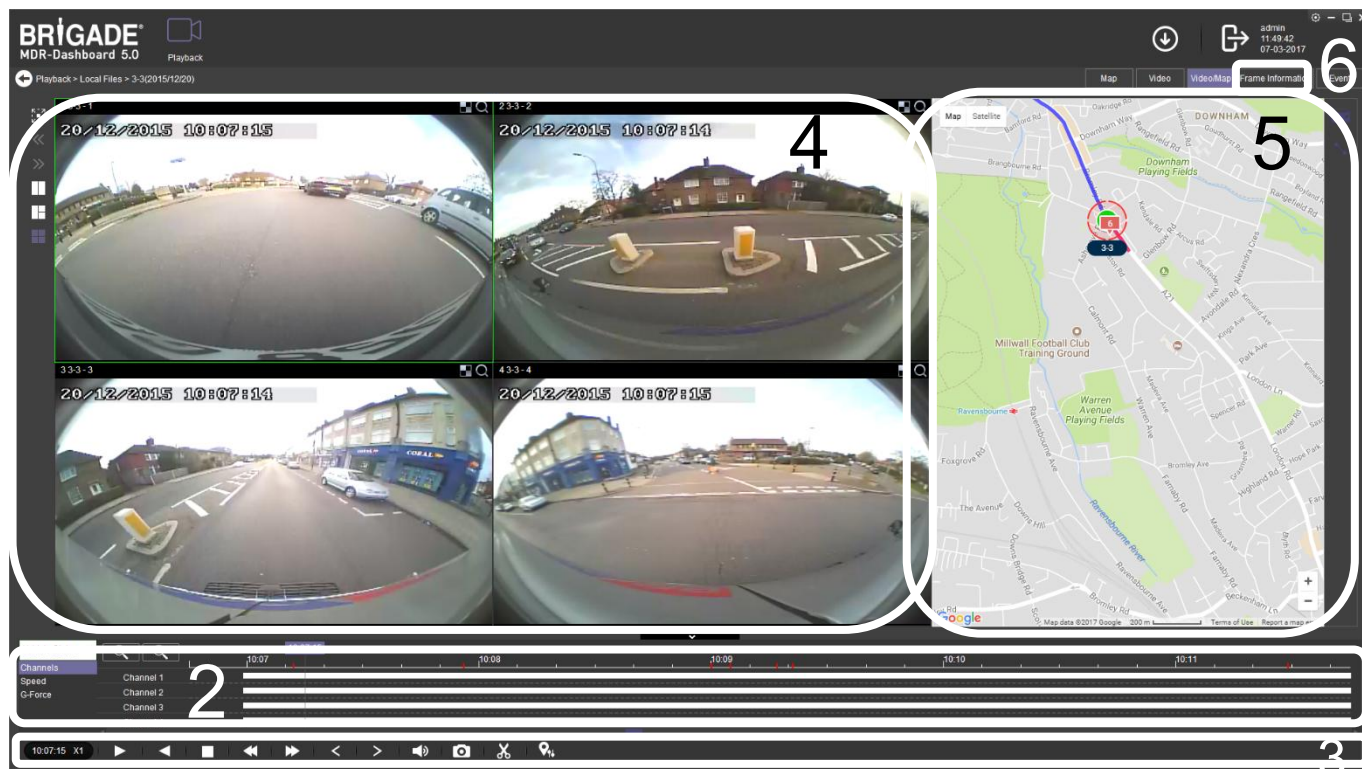

MDR-Dashboard 5.0 User Interface Figure 167

The MDR-Dashboard 5.0 user interface is sub-divided into several numbered areas as illustrated in *MDR-Dashboard 5.0 User Interface Figure 167*:

1. Data Source Access (*Data Source Figure 188*)
2. Graphs Panel
3. Controls Panel
4. Media Playback
5. Map
6. Frame Information

All the above areas are explained in greater detail in the following sections. During playback, users can zoom in/out on the timeline by either using the +/- buttons or the mouse scroll wheel. The vertical blue line can be positioned to the desired time by either dragging it or by clicking on the timeline directly.

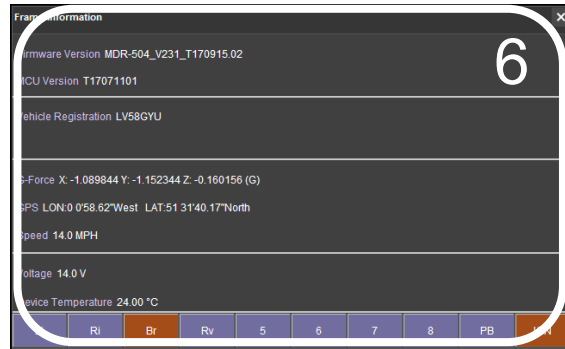

Frame Information Figure 168

9.6.1 Channel Info

- Information about resolution, frame rate and streaming bit rate are shown in all the 4 or 8 quadrants – only in full screen view (area 4).
- On the top left of each image, users can see the MDR-Dashboard channel number followed by the company number, vehicle registration and MDR channel number. *Channel Information Figure 169* shows: “4 3-3 - 4”.
- Access full screen mode of a single channel by double-clicking the desired channel. Exit a full screen view by double-clicking again.
- Audio playback is limited to one channel at a time, single-clicking a channel will access the audio feed – a green outer box visually confirms the current audio feed being accessed.



Channel Information Figure 169

- Each camera channel has two additional features, **BLUR**  and

ZOOM

- Users can use blur to create a mosaic setting of an area which will be blurred throughout video playback. See *Creating Mosaic for Blur Figure 170*, *Setting the Blur Area Figure 171* and *Blur Activated Figure 172*.
- **BLUR** can be applied to a channel for a clipping of a video segment. Click the delete button to remove a blur from a channel.
- **ZOOM** is used to create a magnified view of a selected area of a camera channel. Click the magnifying glass and then choose the desired box area. This is now the only area that will be visible during playback. To exit this view, double-click the camera channel. See *Choosing Zoom Area Figure 173* and *Zoom area Figure 174*.



Creating Mosaic for Blur Figure 170



Setting the Blur Area Figure 171



Blur Activated Figure 172

- **ZOOM** cannot be applied to a clipping – this feature is for viewing a critical area more closely.
-  is used to **ZOOM** in or out of the time scale. Maximum **ZOOM** in is 5 seconds and minimum **ZOOM** out is 24 hours.





Choosing Zoom Area Figure 173



Zoom area Figure 174

9.6.2 Events and Graphs

- Information about events can be viewed by clicking on the **EVENT** button as shown in *Extended View Settings Figure 175*. This will provide a list of all the events.
- Events can also be filtered by clicking on each tab shown in *Event Information Figure 176*. Users may use the arrows to access various tab options. Double-clicking a log in the event list will jump to that point in playback mode.
- OSD settings – the sensor 2-character names are displayed in the event list with brackets. See *Event Information Figure 176*.
- Events can also be ordered based on a user-specific hierarchy.

Click on the  (*Event Information Figure 176*) icon to access and change the order. Use the   shown in *Event Hierarchy Figure 177*.

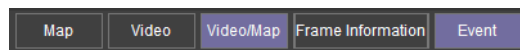

Extended View Settings Figure 175

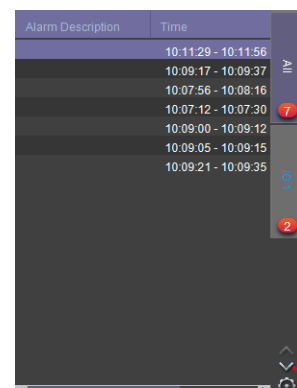

Event Information Figure 176

- See *Event Information Figure 176*. Event information consists of event names, event times and event descriptions (use horizontal scrollbar to view).
- Users can access vehicle information such as
 - Recorded channel data graph based on time
 - Speed graph based on time
 - G-force data graph based on time
- Double-clicking on a graphical point will jump to that time in playback.
- Click the drop-down menu shown in *Graph Options Figure 178* and choose **VEHICLE STATUS**.
- Once the vehicle status sub-menu has been opened as shown in *Vehicle Status Figure 179*, click on the desired option to view the graphical data.

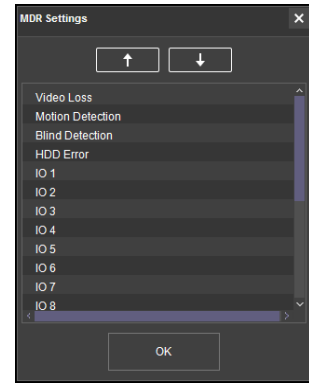

Event Hierarchy Figure 177

- Events are shown clearly using red vertical markers

on all graphs. Hovering over these markers provides users with additional information; see *Channel Graph Figure 181* for an example.

- White video channel bars represent normal recordings. Orange video channel bars represent alarm recordings.

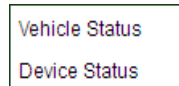

Graph Options Figure 178

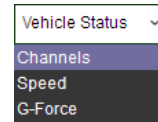

Vehicle Status Figure 179

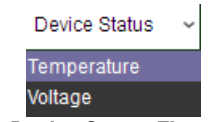

Device Status Figure 180

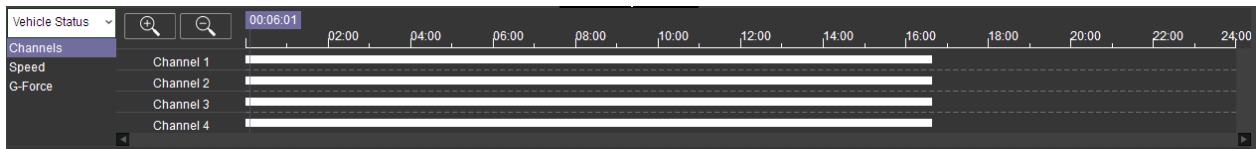

Channel Graph Figure 181

- Users can access device information such as:
 - Device temperature graph based on time – using the built-it temperature sensor
 - Environment graph based on time – not currently supported
 - Voltage graph based on time
- Click the drop-down menu shown in *Graph Options Figure 178* and choose **DEVICE STATUS**.
- Once the device status sub-menu has been opened as shown in *Device Status Figure 180*, click on the desired option to view the graphical data.
- Wheel rotation speed is currently unused.

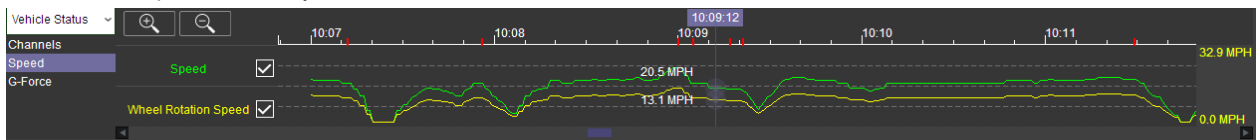

Speed Graph Figure 182

- G-Force is displayed as a triple graph with red, green and yellow lines where each colour represents the X, Y and Z axes respectively.
- These tickboxes can be ticked or unticked depending on the desired graphical information.
- The highest and lowest peaks of the current graph area are shown to the right of every graph.

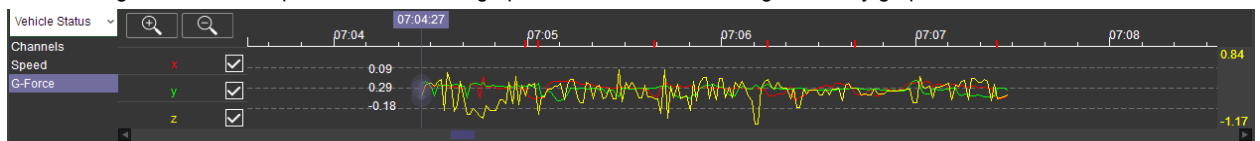

G-Force Graph Figure 183

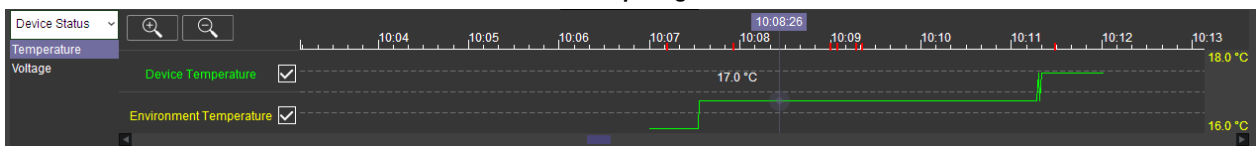

Temperature Graph Figure 184

9.6.3 Frame Information

The Frame Info panel (*Frame Information Figure 185*) provides information about firmware/MCU version, Register Info, vehicle tracking and vehicle information (temperature and voltage).

FRAME INFORMATION consists of:

- Firmware version
- MCU version
- Vehicle Registration
- G-Force
- GPS
- Speed
- Voltage
- Device Temperature

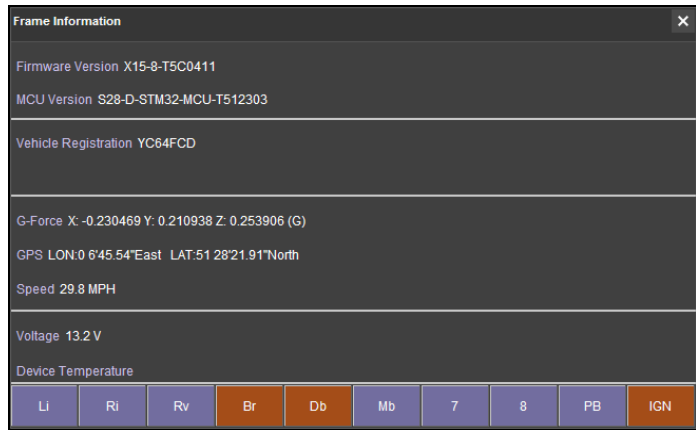

Frame Information Figure 185

9.6.4 Sensor Status

- The 2-character names are set in the OSD menu where users name each sensor. See 7.3.1.1 IO for more information.
- MDR-Dashboard 5.0 displays the status of the sensor triggers at the bottom of the Frame Info (area 6). *Sensor Status Figure 186* shows the ignition (IGN) and the sensor input named Br (Brake) triggered.
- PB (Panic button) and IGN (Ignition) are not configurable.
- By default, your MDR has been set up to show Li (Left Indicator), Ri (Right Indicator), Rv (Reverse camera) and BR (Brake) sensors in the Frame Information.





Sensor Status Figure 186

9.6.5 Map Tracking



The map (area 5) refreshes the position of the vehicle continuously during playback and displays the vehicle registration. Zooming in and out on the map can be done using the +/- buttons.

- There are two map view settings that can be turned on/off:
- Lock map to vehicle automatically
- Show Line/Hide Line

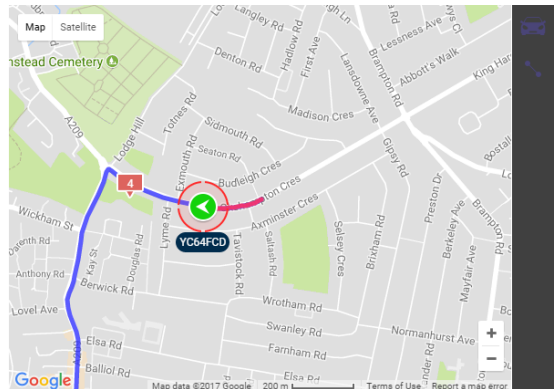
- Click the Lock Map button  to ensure that the vehicle is always shown in the centre of the map. If this is turned off then the map can move freely regardless of the vehicle position.
- Click the Line button  which will turn the vehicle route track line on or off depending on this setting. It is advised to have this turned on.
- The red trace indicates the route that has been travelled while the blue represents the route the vehicle will travel. Google Maps Satellite View is also supported.



Map Tracking Figure 187

- A hazard symbol  on the map will show points where an alarm was triggered. If there are multiple alarms in close succession, a box  indicating the number of alarms will be shown on the map . Click on these icons to access additional information about the alarm.
- Video playback will move to the event point if this is clicked on.

Note: As an alternative, MS Bing maps can be chosen. Changing maps requires restarting the MDR-Player 5.0 which will be requested once the setting has been changed.

9.7 Loading from a USB flash drive or Folder

This procedure applies to recordings previously downloaded from the MDR and saved onto a USB flash drive or saved onto a PC.

- To read exported files, click on the Local Files tab found on the Data Source Access (area 1). See *Data Source Figure 188*.

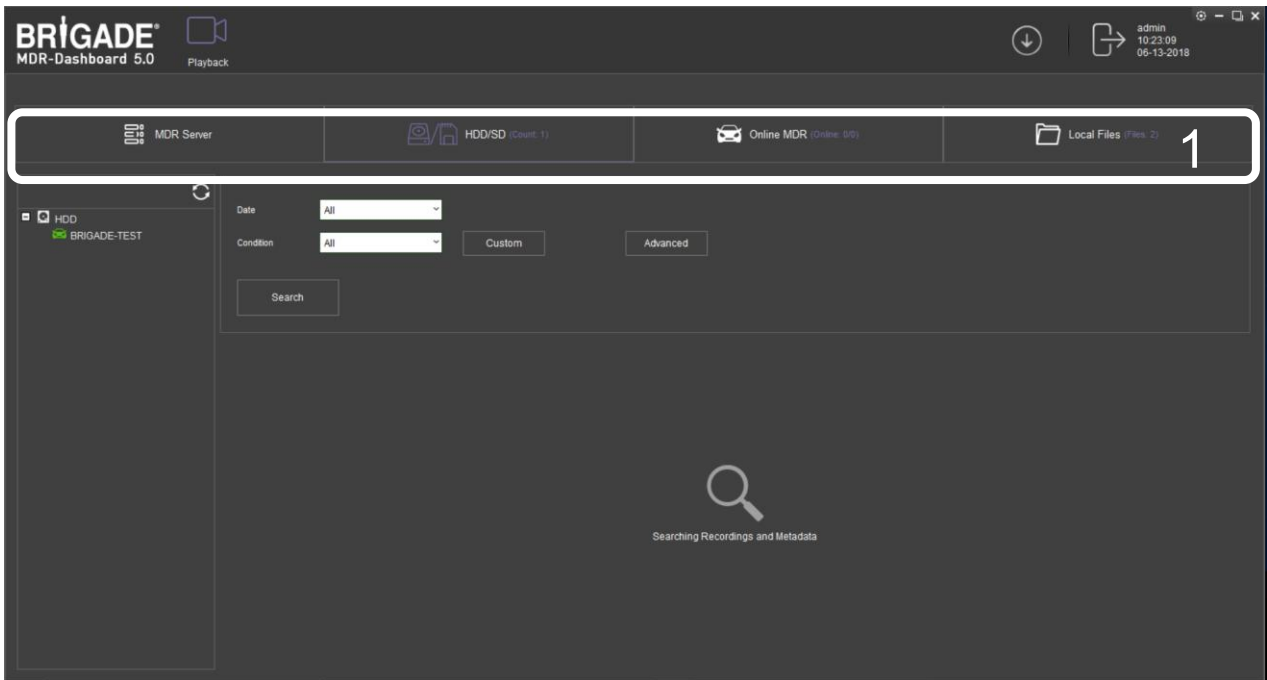

Data Source Figure 188

- Users click on the **Local file** tab as shown in *Local Files Tab Figure 189*.
- Click the **ADD** button as shown in *Directory Add Figure 190*. Browse to the relevant folder and click **SELECT FOLDER**.
- This brings up a Windows™ Explorer dialogue box (*Windows Explorer Folder Figure 191*) which allows users to select the folder that contains the recordings. Select the MDR Vehicle name, in this example 3-3.
- Once the folder has been successfully loaded, it will appear as shown in *Clipping Directory Figure 192*.
- If there was a directory specified previously, click the refresh icon  to get the directory to appear. This will be a green icon to indicate it is available for browsing.
- Double-click the vehicle icon. This will display **ALL** calendar events. A typical example of a calendar is shown in *HDD Calendar Figure 196*.
- The directory will now appear in the left pane as shown in *Clipping Directory Figure 192*.
- Multiple directories can be specified. Directories may be searched. See *Directory Search Figure 193*. Custom and Advanced searches can be configured. See *Windows Explorer Folder Figure 191* and *Advanced Search Settings Figure 195*.

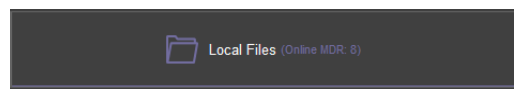

Local Files Tab Figure 189

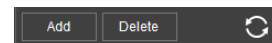

Directory Add Figure 190

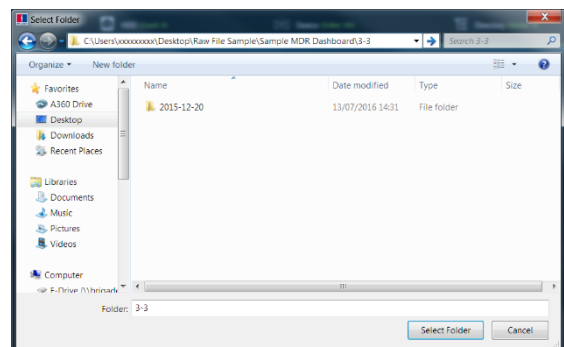

Windows Explorer Folder Figure 191

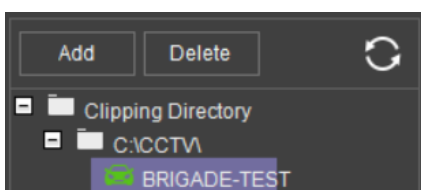

Clipping Directory Figure 192

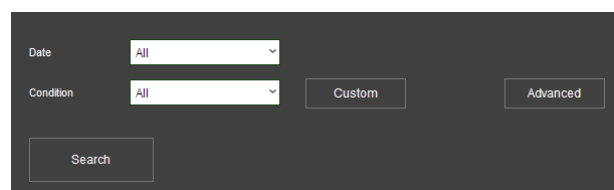

Directory Search Figure 193

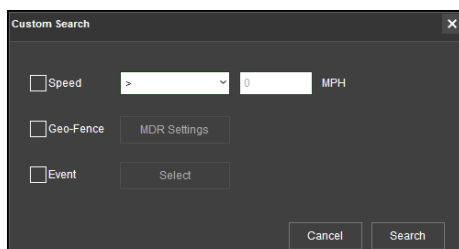

Custom Search Figure 194

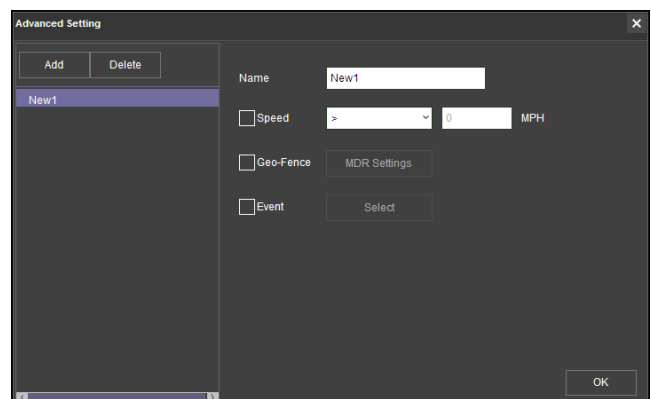

Advanced Search Settings Figure 195

9.8 Reading Data

- Double-click the vehicle icon . This will display ALL calendar events.
- Each colour represents:
 - Green dates represent normal recordings
 - Orange dates represent alarm recordings
 - Red dots represent metadata data
 - Blue outline represents the current date (today's date)
- Metadata is treated as separate data sets, store 30 recording days maximum (work on calendar dates)
- A typical example of a calendar is shown in *HDD Calendar Figure 196*.
- To refine the data displayed, users should setup the search criteria. Custom and Advanced searches can be created. *HDD Search Figure 197*.
- Ensure that the **DOWNLOAD METADATA** is always ticked. See *Metadata Setting Figure 198*. This will ensure that all metadata (graphical) is shown with playback video.
- Users double-click on the relevant calendar date. This will then display the pre-playback screen. See *Pre-playback Figure 199*. Users can choose which channels to view during playback.

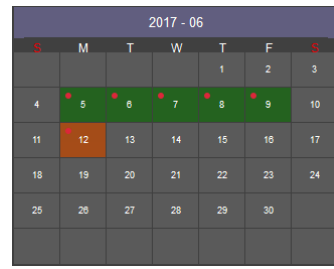

HDD Calendar Figure 196

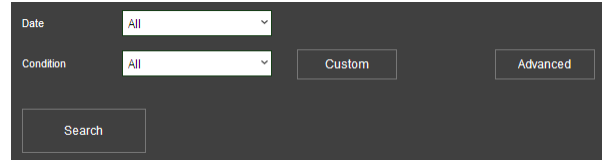

HDD Search Figure 197

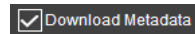

Metadata Setting Figure 198

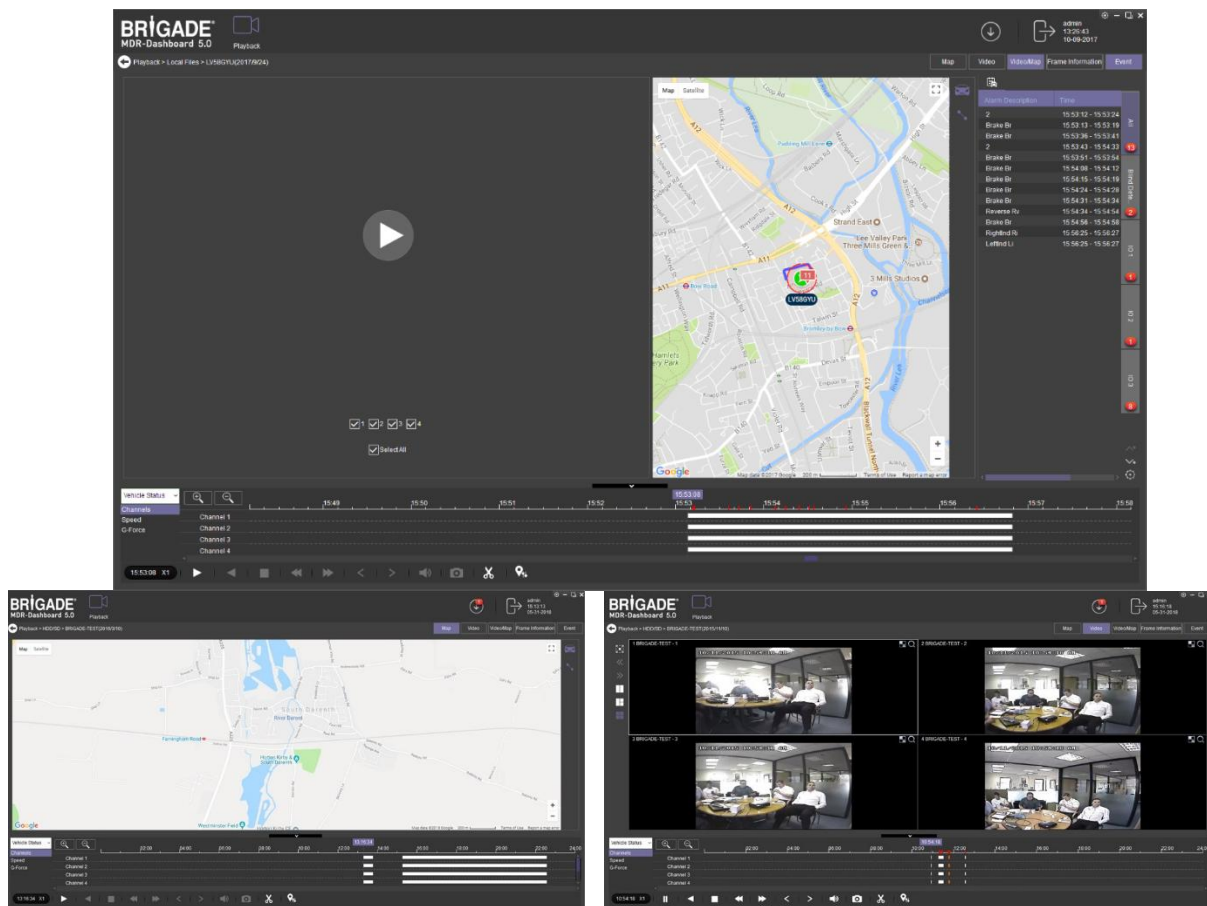

Pre-playback Figure 199

- Users can access different view settings such as **MAP**, **VIDEO** and **VIDEO/MAP**. See View Options Figure 200.
- Frame information and Event information can also be accessed from this panel. To return to the calendar view from the current playback, click the back arrow . See Return to Calendar Figure 201.

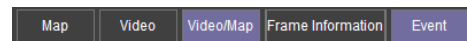

View Options Figure 200

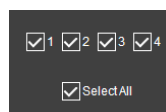

- Choose which channels to playback.
- Click the Play button  to display the data.

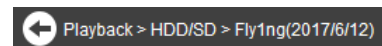

Return to Calendar Figure 201

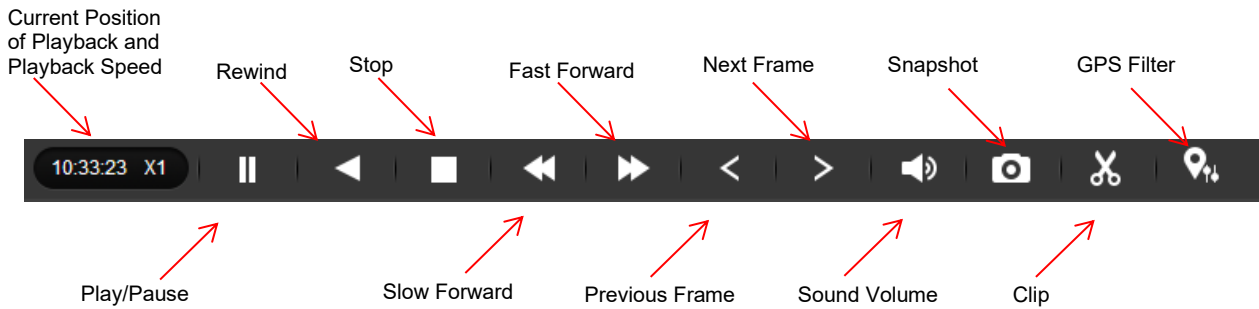



MDR-Dashboard 5.0 Controls Panel Figure 202

- **Fast Forward** options (1x, 2x, 4x, 8x, 16x, 32x). Maximum
- **Slow Forward** options are 1/2, 1/4, 1/8, 1/16 and 1/32.
- Double-clicking an individual channel to make it full screen. There are other video viewing options as shown in *Video View Options Figure 203*. This is dependent on model (4 channels or 8 channels).
 - > Full Screen
 - > Previous Page
 - > Next Page
 - > Three Windows
 - > Four Windows
 - > Six Windows
 - > 9 Windows



Video View Options Figure 203

9.9 Exporting Videos



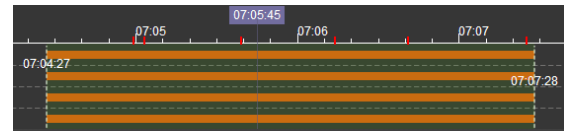

- Click on the **CLIP** button . Only accessible during while video is being played or paused.
- Green clip markers appear (broken vertical lines). See *Clipping a Video Figure 204*.
- Select the start and end time for the clip by dragging and dropping to the desired time, users may also make fine adjustments to the times by typing. See *Clip Settings Figure 205*.
- Once satisfied click on the **OK** button .
- The following window will appear to choose the channels, clipping time (when unhappy with the markers) and the kind of exporting function. There are three types of exporting:
 - > Standard
 - > Export
 - > MP4
- The **STANDARD** option cuts the clip and creates a folder structure containing the video files in original proprietary format (H264) onto a local storage device (e.g. HDD).
- Note: Users are not allowed to use the same location as the original folder. Once clipped, the files will be found in a folder named with the following format: `\Company_Name-Vehicle_Number\YYYY-MM-DD\record`

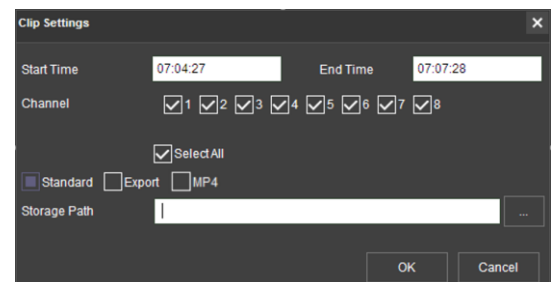

Clipping a Video Figure 204



Clip Settings Figure 205

- The **EXPORT** option allows users to export clips into a single .exe file with an embedded MDR-Player 5.0. This option is the recommended solution as it contains metadata and the Clip. It **MUST** be password protected and played without the need of any additional player software. If a password is not created, the file will not be accessible. **Maximum size of the file is 1GB to 1.5GB depending on system.**
- The **MP4** option creates .MP4 files playable by common players such as Windows Media Player (WMP™) and Video Lan Client (VLC). The advantages of this solution are the portability of the format. The disadvantage is the lack of protection and missing metadata. These files can be played and edited by anyone. The only information contained in the video image is selected by the OSD options.
- Users may monitor the progress of current/completed download tasks under in the downloads area. Click the  button.
- See *Current Download Tasks Figure 206*. Task priority is a first come first serve basis. If another task has a higher priority, use  to stop a task and the  to start the priority task. If an error is made, tasks made be deleted using the .

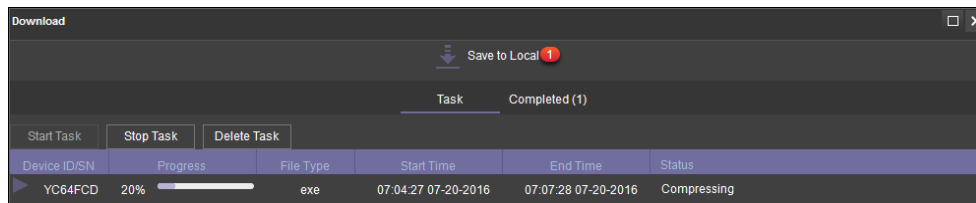

Current Download Tasks Figure 206

- Completed tasks automatically move to the Completed tab, see *Completed Download Tasks Figure 207*.
- Right-click a completed task to access a sub-menu as shown in *Completed Sub-menu Figure 208*.

Device ID/SN	Status	Start Time	End Time	File Type	Set Path
MDR-504SZ	Completed	10:20:47 06-22-2020	10:21:33 06-22-2020	mp4	C:\USERS
MDR-504SZ	Completed	10:20:47 06-22-2020	10:21:33 06-22-2020	264	C:\USERS
MDR-504SZ	Completed	10:20:47 06-22-2020	10:21:33 06-22-2020	264	C:\USERS
MDR-504SZ	Completed	10:20:47 06-22-2020	10:21:33 06-22-2020	exe	C:\USERS

Completed Download Tasks Figure 207

Task	Completed (4)
Start Time	End Time
10:20:47 06-22-2020	10:21:33 06-22-2020
File Type	Set Path
mp4	C:\USERS
264	C:\USERS
264	C:\USERS
exe	C:\USERS

Completed Sub-menu Figure 208

9.10 Saving Snapshots

- Click the desired channel; this will be highlighted by a green outline.
- Click on the Snapshot button in the Controls Panel.
- A pop-up window will be displayed on the bottom right corner of the desktop (next to the time/calendar). The snapshot location is also shown here (See *Snapshot pop-up Figure 209*).

Snapshot Successful
C:\USERS\ [redacted] \APPDAT
A:\M\ING\MDR-DASHBOARD
5.0\CONFIG\PHOTO\PB_Fly1ng_1_2017
0612131936.bmp

- Click on the Snapshot Successful information to access the **IMAGE FILTER**, this shows all historic locally stored snapshots. See *Snapshot Image Filter Figure 210*.

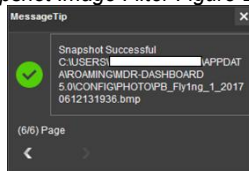

Snapshot pop-up Figure 209



Snapshot Image Filter Figure 210

9.11 User and System settings

- The current logged in username, date (Client PC) and time (Client PC) is displayed. See *User and System Area Figure 211*.

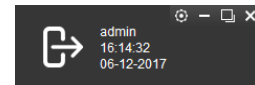

User and System Area Figure 211

- This area is used to logout. This is achieved by clicking on the logout icon . This brings up a confirmation window for logging out. Click **YES** or **NO** and thereafter the MDR-Dashboard 5.0 login screen will be displayed. See *Logout Screen Figure 213*.

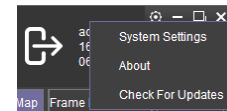

MDR-Dashboard 5.0 Settings Menu Figure 212

- Click on the gear icon to display a submenu containing **SYSTEM SETTINGS** and **ABOUT** options. See *MDR-Dashboard 5.0 Settings Menu Figure 212*.
- The **ABOUT** option will display the window shown in *About Figure 214*. This will show the current MDR-Dashboard 5.0 version.
- The **Check for Updates** option will take the user to the brigade website where relevant updates can be downloaded.

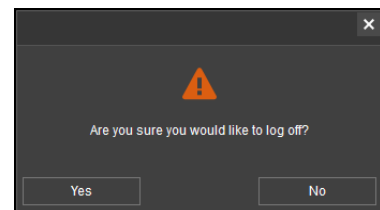

Logout Screen Figure 213

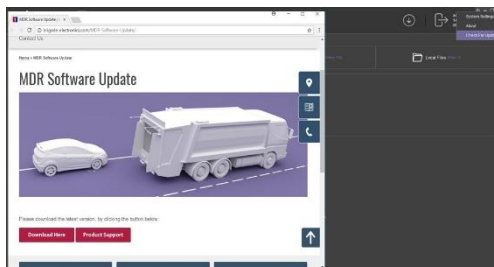

Check for Updates Figure 192a

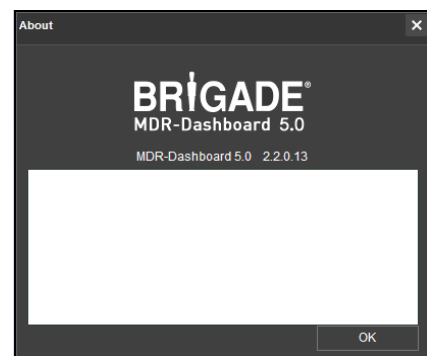

About Figure 214

- Refer to the **SYSTEM** window in System Settings Figure 217. This area is used to configure the following:
 - > Path for Snapshots
 - > Map Type – Google map or OS Map
 - > Language – English, Spanish, Russian, Portuguese, Polish, Italian, German, French, Dutch available
 Note: If the language can't be displayed properly, please follow steps below for troubleshooting:

- Install Windows language pack
Go to Windows Settings-> Time & language-> Region & language->Add a language-> Install the language you want to display
- Change location
Go to Control Panel-> Clock and Region-> Region-> Administrative ->Change system locale-> Change to the country/location which speaks the language.

- > Speed Unit
- > Temperature Unit
- > Automatically switches to the main stream – Unused
- > Loop Playback Video – this will play the entire selected video on repeat. This feature can be used for HDD or directory playback
- > Auto-logout – Automatically logout the MDR-Dashboard 5.0 client after certain amount of time.
- > Auto-Close Video – Automatically stop liveview after certain amount of time, considering save data usage and avoid people accidentally leave the liveview always on.
- > Skip Time Duration(seconds) – defines time skip duration when play back local files. User can use keyboard left and right key to forward or backward the time stamp while playing. The default amount is 10
- > Alarm Settings Count (Server mode only) – shows the historical alarm and events in the alarm log area. The default amount is 200.
- > Alarm Settings Time (Server mode only) – shows the alarm and events for the past time range setting in the alarm log area. The default amount is 30 minutes.

Note: Because Russian uses different characters from other languages, if you want to change the software to Russian, please download the Russian language pack from Windows first.

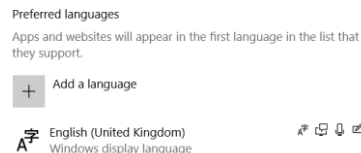

Install Language Pack Figure 215

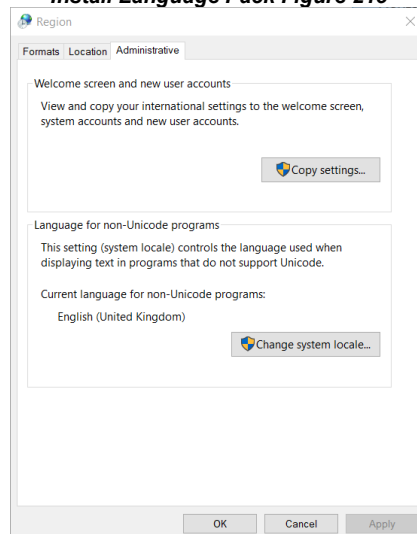

Change Location Figure 216

- System Settings is comprised of 2 windows – **System** and **Permission** Settings. System Settings are shown in System Settings Figure 217
- See the **PERMISSION SETTINGS** window shown in *Permission Settings Figure 218*. This area is used to setup local user logins.
- Only the **ADMIN** account can create new local user accounts.
- Any local user accounts are for users that will login using the **SAME PC** but require different levels of access.
- These accounts can be assigned passwords. This is also where the permissions for each local user are set. Passwords should be noted down by each user.

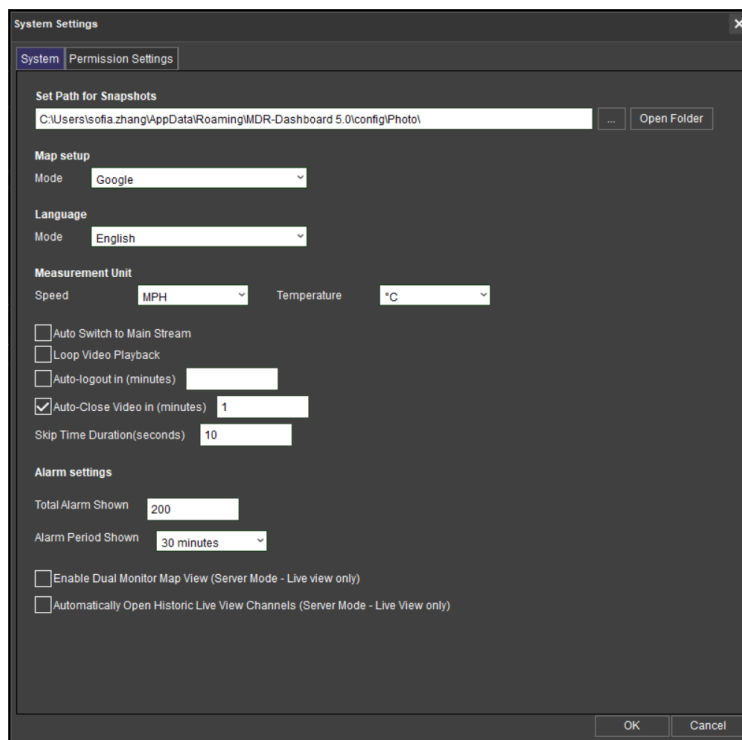

System Settings Figure 217

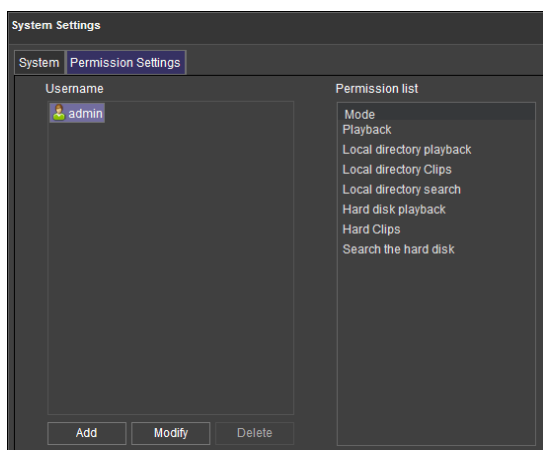

Permission Settings Figure 218

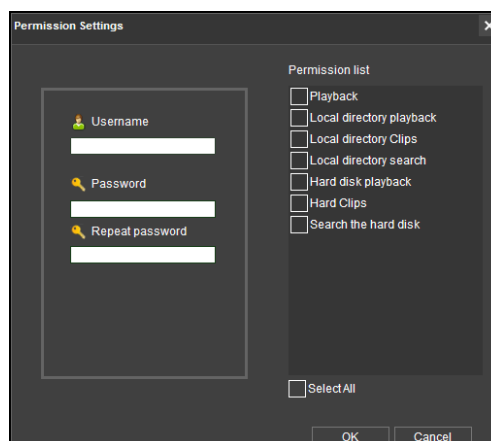

Adding a Local User Figure 219

10 MDR-Player 5.0

MDR-Player 5.0 is like MDR-Dashboard 5.0 visually and in operation. MDR-Player 5.0 is used mainly to playback executable video files (.exe). The system is compatible with a PC running Microsoft Windows™ 7, 8.x (32-bit or 64-bit version) and 10 operating systems. To understand the key feature differences between the software, please see the Table below:

MDR-Dashboard 5.0 vs MDR-Player 5.0

MDR-DASHBOARD 5.0	MDR-PLAYER 5.0
Installation Required	Direct Executable File
Playback Sources – Server HDD, Local HDD, Local SD Evidence, Remote Device and Directory Playback (Clippings)	Playback Sources – Exported files (password protected .exe) and Directory Playback (Clippings)
Live Mode, Playback Mode and Evidence Mode	Playback Mode
View, Clip and Export Recordings	View Recordings
Choice of Snapshot	Individual Snapshot
View Events and Logs	No option to view events and logs
Channel Blur and Zoom	No Channel Blur and Zoom

10.1 Exported MDR-Player 5.0

- The embedded MDR-Player 5.0 is a single executable file that can be password protected (user choice) which is generated by the MDR-Dashboard 5.0.
- The file contains an exported clip with the MDR-Player 5.0. By double-clicking on the .exe file, the MDR-Player 5.0 is launched and automatically displays the recordings with metadata. See *Exported MDR Icon Figure 220* and *Password Prompt Figure 221*.



Exported MDR Icon Figure 220

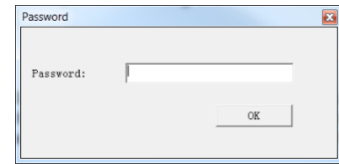

Password Prompt Figure 221

10.2 Setting up MDR-Player 5.0

- MDR-Player 5.0 does not require any installation. If you have already installed MDR Dashboard 5.0, MDR-Player 5.0 can be accessed in the start-up menu or via a shortcut found on the desktop.
- See *MDR-Player 5.0 Icon Figure 222*. Double click on the Brigade logo named MDR-Player 5.0 to start the program.

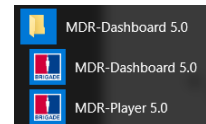

MDR-Player 5.0 Icon Figure 222

10.3 Basic Operations

MDR-Player 5.0 allows three ways of loading the data:

- From a clip with embedded MDR-Player 5.0 (as explained in section 10.1)
- Opening a file

Users may access the following information using the dropdown menu. See *Vehicle Status Figure 223*:

- Channel
- Speed
- G-Force
- Temperature
- Voltage

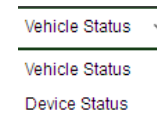

Vehicle Status Figure 223

The following interface will appear as shown below. *MDR-Player 5.0 Figure 224* illustrates a multiple camera view, a timeline with control buttons and a Google Maps view.

Note: To use the maps feature, an internet connection is required.

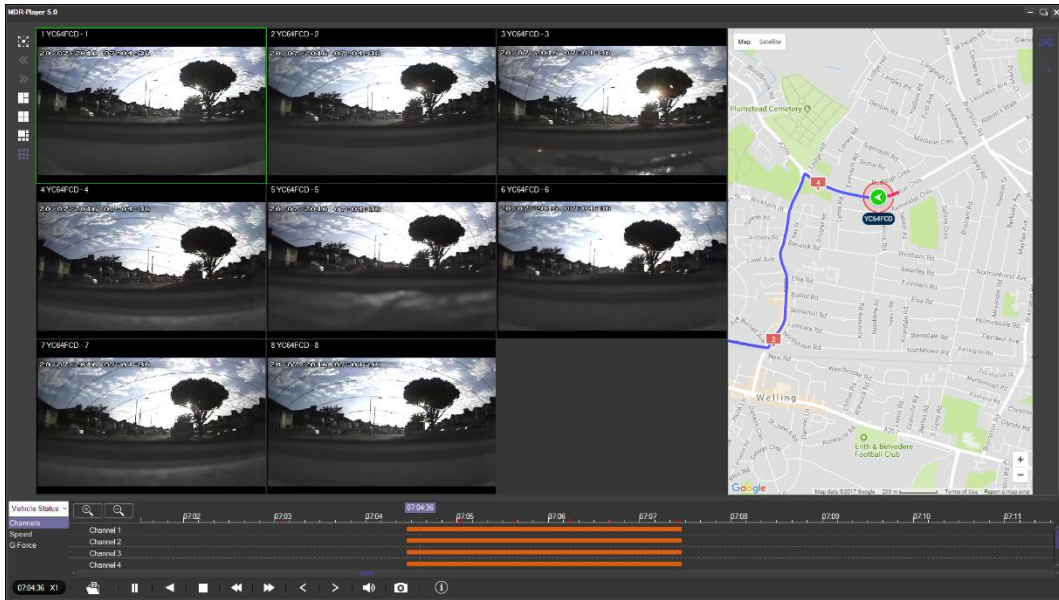

MDR-Player 5.0 Figure 224

The toolbar (MDR-Player 5.0 Controls Panel Figure 225) has the following options:

- Open File
- Pause
- Rewind
- Stop
- Slow Forward (x1/2 or x1/4)
- Fast Forward (x2 or x4)
- Previous Frame
- Next Frame
- Sound
- Snapshot – takes a screenshot of the selected channel which are stored in C:\Users\- Frame Information

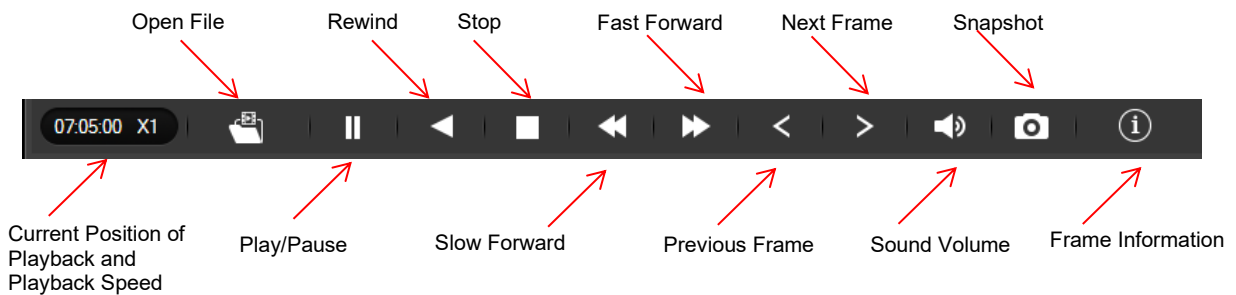

MDR-Player 5.0 Controls Panel Figure 225

To access local clippings (H.264) click the **OPEN FILE** icon . Selecting **Open File** (Open File Figure 226), a Windows™ Explorer browsing dialogue is displayed. Navigate to the folder where the **.h264 native files** are. If users select the file for one single channel, MDR-Player 5.0 will automatically load the other channels (if present) corresponding to the same time frame.

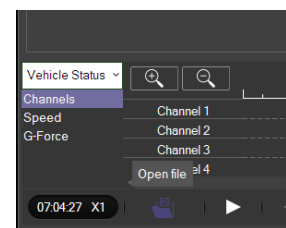

Open File Figure 226

Clippings (H.264 files) created with previous version MDR-Dashboard 1.0 can only be played with MDR-Player 1.0. Clippings created with MDR-Dashboard 5.0 can only be played using MDR-Player 5.0. Selecting **Open File** requires users to browse and select a **folder by date** as illustrated (File Browser Figure 227).

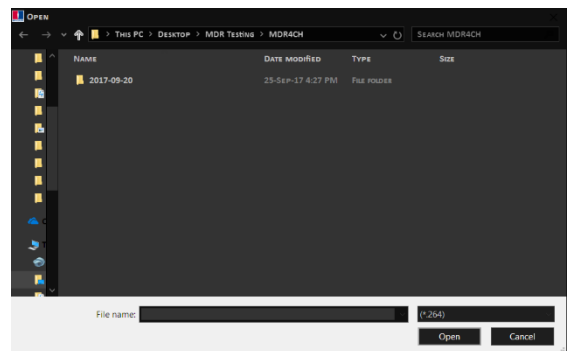

File Browser Figure 227

Once the data has loaded, users can play the videos. Double clicking on a single channel image would trigger this channel into full screen. Audio playback from channel 1 is played when multiple channels are displayed. Users can select a different audio source by single clicking another channel image. During playback, users can zoom in/out on the timeline by either using the +/- button or by using the mouse scroll wheel.

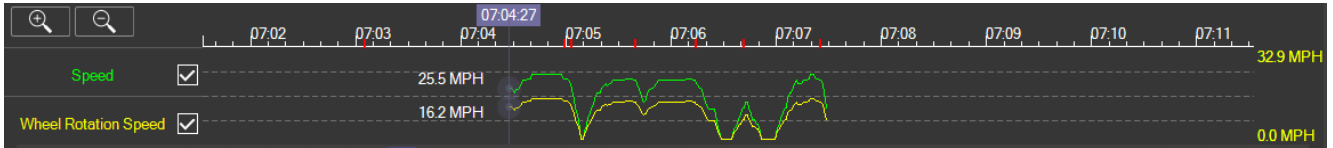

Speed Graph Figure 228

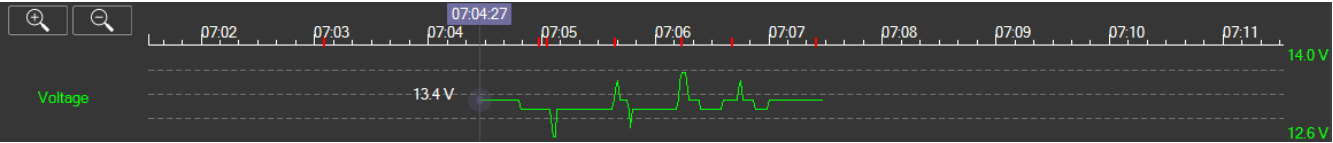

Voltage Graph Figure 229

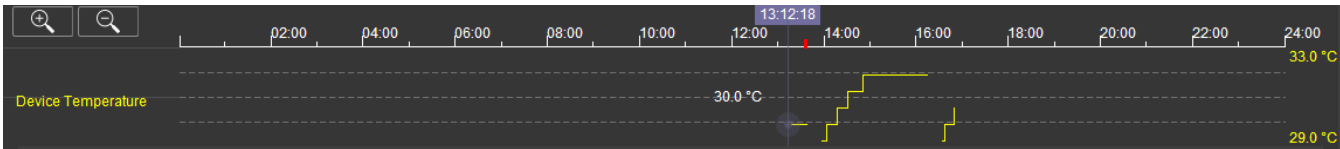

Temperature Graph Figure 230

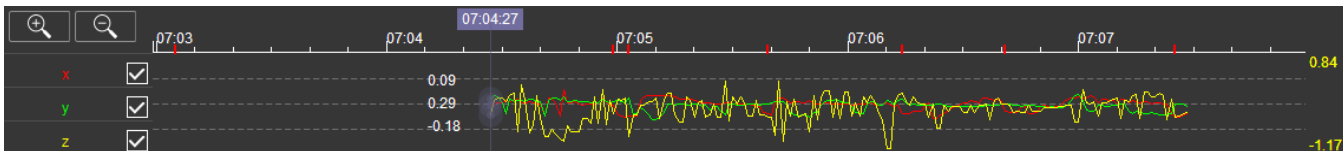

G-Force Graph Figure 231

Use the  icon to access frame information. Information such as sensor trigger status, GPS location, Firmware/MCU and video recording parameters are displayed (*Frame Information Figure 161*).

Firmware and
MCU Versions

GPS Location

Frame Information

Firmware Version X15-8-T5C0411

MCU Version S28-D-STM32-MCU-T512303

Vehicle Registration YC64FCD

G-Force X: -0.171875 Y: 0.253906 Z: 0.292969 (G)

GPS LON: 0 6°46.15'East LAT: 51 28'21.67"North

Speed 30.5 MPH

Voltage 13.2 V

Device Temperature

Li	Rt	Rv	Br	Db	Mb	7	8	PB	IGN
----	----	----	----	----	----	---	---	----	-----



Trigger Status e.g. **Br** (Brake Trigger)

Frame Information Figure 232

In the maps (below) tracking information refreshes continuously while playing and displays the vehicle registration. Zooming in and out on the map can be done using the +/- buttons; or by using the mouse scroll wheel.

Note: The Hand tool allows users to move the map, but the image is periodically refreshed to keep the vehicle in the centre of the map. The red trace indicates the route that has been travelled while the blue represents the route ahead. Google Maps Satellite is also supported on the MDR-Player 5.0.

The map area has two options when viewing GPS data. When the icons are green, this implies that this feature is active.

- Lock map to vehicle automatically . This means that the vehicle will be centred in the map and users will be unable to move the map freely.
- Show Line/Hide Line  is used to show the tracking data of the vehicle's route.

There are also **zoom in** and **zoom out** buttons located on the bottom right of the map.

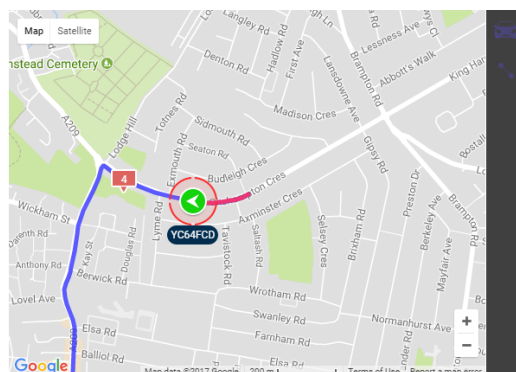

MDR-Player 5.0 Map Figure 233

11 Advanced Ethernet Configurations

This section is dedicated to an advanced feature for individuals with networking knowledge which enables users to:

- Live View of Cameras
- Playback and download of recordings
- View and download of logs
- Configure MDR unit settings

This feature is not recommended for field operations, diagnosis and configuration.

Warning: The web interface menu below does not match the OSD menu found on the MDR. Terminology may differ but the same settings can be found.

Warning: To achieve full functionality (snapshots, downloads, live view etc.) open Internet Explorer by running as Administrator for Windows 8 and Windows 10 operating systems.

Note: The configuration requires a Cat5e cable, a Microsoft Windows™ Operating system; a PC with an Ethernet RJ45 port and a wireless adapter with Internet Access (may be needed to download the plugin).

Warning: Playback, Live view and Maintenance features are dependent on your Internet Explorer version.



Internet Explorer Version Figure 234

11.1 Ethernet Setup

- Connect an Ethernet cable to the PC and Ethernet LAN port on the back of the MDR.
- The following steps apply to PCs running Windows 7 upwards. Before making changes to the PC's network settings, ensure all work is saved.
- **Local Area Connection Properties Figure 235** shows the network configuration window. This dialog may be accessed by right clicking on "Open Network and

Sharing Centre" on the desktop . Select the appropriate network interface by double clicking.



Local Area Connection Properties Figure 235

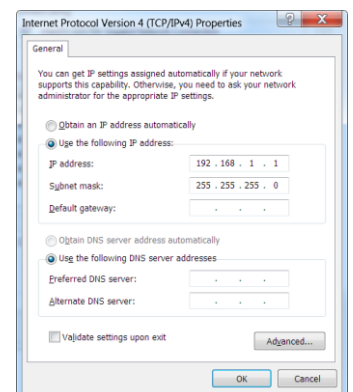

Internet Protocol Version 4 Figure 236

- Select the "Internet Protocol Version 4 (TCP/IPv4)" item and click "Properties". **Internet Protocol Version 4 Figure 236** is displayed; an IP address should be entered in this box; **192.168.1.1** is shown in the example. (This address is on the same subnet as the MDR, which has a default IP address of **192.168.1.100**).
- To locate the MDR IP, log into the MDR menu, go to **Basic Setup** → **Ethernet** and check the IP address.
- To change, type the new IP address and click save.



MDR Network Settings Figure 237

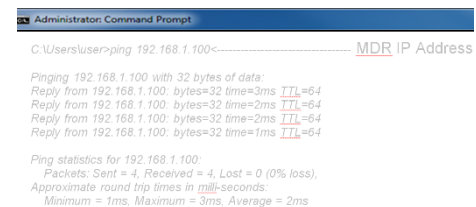

Results from Command Prompt Figure 238

- To test the PC connection to the MDR, open the Command prompt by typing cmd within the start-up menu. Ping the MDR IP address by typing **ping 192.168.1.100**. These results are shown in **Results from Command Prompt Figure 238**.
- Open an Internet Explorer web page and type the following **http://192.168.1.100**. A pop-up window will appear in Internet Explorer requesting permission to allow the installation/running of a plugin "N9M_ACTIVEX". See **Plugin Pop-up Figure 240**.
- Allow the plugin and its installation.
- After the plugin is successfully installed, the login window (**Web User Login Figure 241**) will appear.
- Enter the appropriate password (same as MDR unit login) to grant the correct permissions, and then click **LOGIN**.



Internet Explorer Web Address Figure 239

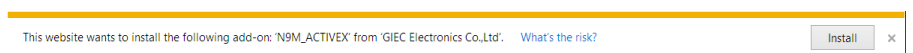

Plugin Pop-up Figure 240

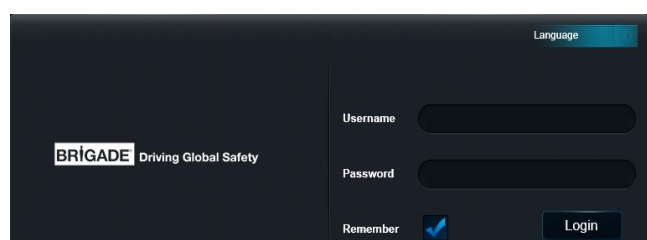

Web User Login Figure 241

11.2 Ethernet Operation

- Once logged in, 5 tabs will be displayed as follows: **PLAYBACK**; **LIVE VIEW**; **MAINTENANCE**; **LOG** and **SETUP**. See *Web Application Manager Figure 242*.
- PLAYBACK** tab allows users to view and download recordings.
- Live view tab allows users to view the live cameras.
- MAINTENANCE** shows you basic information, device module information, storage device information and version information.
- LOG** is used to display and export logs.
- Setup** is used to configure MDR settings such as basic setup, surveillance, events and alarms.
- PLAYBACK** tab allows users to view and play recordings. Users can **SEARCH** by date, type, time, channel and the source of the recording.
- Clicking various calendar dates will automatically load video data in the timeline.
- Snaps are saved in the following path (Default):
C:\Users\Administrator\NVR\192.XXX.XXX.XXX\CAPTURE\CHXX
Note: Please use admin account to operate, also use admin authority to open the IE web browser (right click run as administrator), or snaps will be saved in a Windows temp folder called:
C:\Users\XXXXX\AppData\Local\Microsoft\Windows\INetCache\Virtualized\C\Users\XXXXX\NVR\XXX.XXX.XXX.XXX\CAPTURE. This folder is invisible most of the time. Please follow online instructions to unhide those folders as needed.
- See the toolbar and the view options shown below:



Playback Toolbar Figure 243



Playback View Options Figure 244

- PLAYBACK** will also show a record list based on your search which can be downloaded. You can access this by clicking on Record List found below the Search button.
- Tick which channels you would like to download then click Backup.
- Then a pop-up window will ask for that data type.
- Proprietary and AVI data is stored in the following path (Default):
C:\Users\Administrator\NVR\192.168.14.219\BACKUP
Note: Please use computer admin profile to operate, also use admin authority to open the IE web browser (right click run as administrator), or record date will be saved in a Windows temp folder called:
C:\Users\XXXXX\AppData\Local\Microsoft\Windows\INetCache\Virtualized\C\Users\XXXXX\NVR\XXX.XXX.XXX.XXX\BACKUP. This folder is invisible most of the time. Please follow online instructions to unhide those folders as needed.

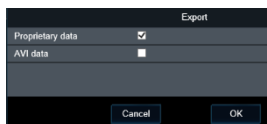

Web Export Figure 246



Export Status Bar Figure 247

- Live view is used to view live cameras. Audio is also accessible. The green outline indicates which channel's audio is playing.
- See view options below. Snaps are saved in the same path as above. Each channel settings can be adjusted individually such as brightness, colour, contrast and saturation using .
- You can switch between main stream and sub stream using options in *Live Stream Options Figure 251*.



Live View Options Figure 249



Web Application Manager Figure 242

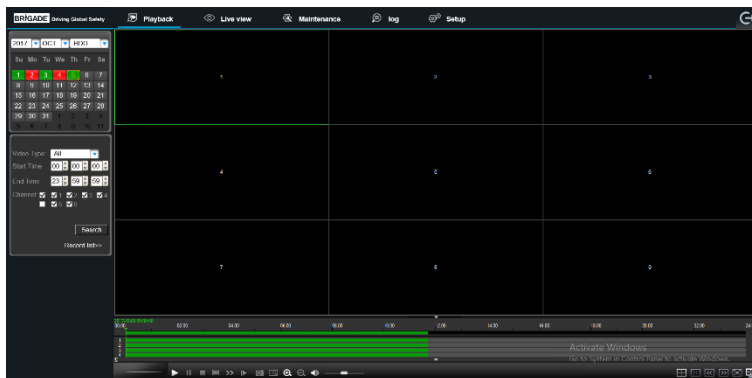

Playback Figure 245

Channel	Start Time	End Time	Video Type	Status
1	11:21:00	11:21:15	Normal	
2	11:21:00	11:21:15	Normal	
3	11:21:00	11:21:15	Normal	
4	11:21:00	11:21:15	Normal	
5	11:21:00	11:21:15	Normal	
6	11:21:00	11:21:15	Normal	
7	11:21:00	11:21:15	Normal	
8	11:21:00	11:21:15	Normal	
9	11:21:00	11:21:15	Normal	
10	11:21:00	11:21:15	Normal	
11	11:21:00	11:21:15	Normal	
12	11:21:00	11:21:15	Normal	
13	11:21:00	11:21:15	Normal	
14	11:21:00	11:21:15	Normal	
15	11:21:00	11:21:15	Normal	
16	11:21:00	11:21:15	Normal	
17	11:21:00	11:21:15	Normal	
18	11:21:00	11:21:15	Normal	
19	11:21:00	11:21:15	Normal	
20	11:21:00	11:21:15	Normal	
21	11:21:00	11:21:15	Normal	
22	11:21:00	11:21:15	Normal	
23	11:21:00	11:21:15	Normal	
24	11:21:00	11:21:15	Normal	
25	11:21:00	11:21:15	Normal	
26	11:21:00	11:21:15	Normal	
27	11:21:00	11:21:15	Normal	
28	11:21:00	11:21:15	Normal	
29	11:21:00	11:21:15	Normal	
30	11:21:00	11:21:15	Normal	
31	11:21:00	11:21:15	Normal	
32	11:21:00	11:21:15	Normal	
33	11:21:00	11:21:15	Normal	
34	11:21:00	11:21:15	Normal	
35	11:21:00	11:21:15	Normal	
36	11:21:00	11:21:15	Normal	
37	11:21:00	11:21:15	Normal	
38	11:21:00	11:21:15	Normal	
39	11:21:00	11:21:15	Normal	
40	11:21:00	11:21:15	Normal	
41	11:21:00	11:21:15	Normal	
42	11:21:00	11:21:15	Normal	
43	11:21:00	11:21:15	Normal	
44	11:21:00	11:21:15	Normal	
45	11:21:00	11:21:15	Normal	
46	11:21:00	11:21:15	Normal	
47	11:21:00	11:21:15	Normal	
48	11:21:00	11:21:15	Normal	
49	11:21:00	11:21:15	Normal	
50	11:21:00	11:21:15	Normal	

Record List Figure 248

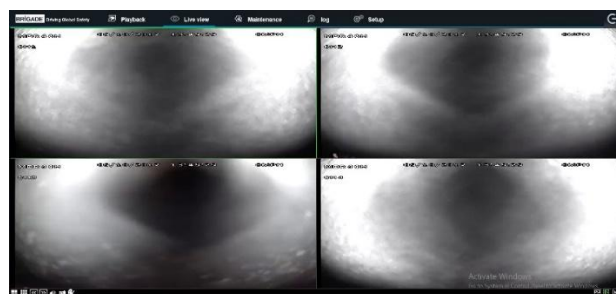

Live View Figure 252

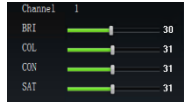

Live Channel View Settings Figure 250



Live Stream Options Figure 251

11.3 Ethernet Maintenance

- Basic information displays the current and historic state of camera channels. This can be due to several reasons such as damage, poor contact and installation.
- Device module displays information with regards to the mobile network, Wi-Fi and GPS module. See below:

Mob Net	Network Type	Unknown
	Module Status	Detected
	SIM Status	SIM Not Detected
	Signal Level	(0 dBm)
	Dial Status	Unknown
Wi-Fi Module	Module Status	exist
	Signal Level	
	MAC Address	28:A1:EB:FB:9C:7A
GPS	Module Status	Normal
	Location source	GPS
	GPS Satellite Count	13

Ethernet Module Information Figure 253

- Storage Device** is used for varied features. It shows all storage devices, HDD, SD(Internal), SD(FPB) and FRONT USB. The free/total capacities are displayed.
- You can format a chosen storage device by clicking . See below for format confirmation window.
- Under the **Local Storage** section, you define the path used for snaps and video backups. By default, this is set to:
C:\Users\Administrator\NVR\

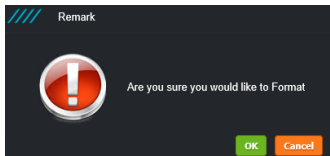

Ethernet Format Confirmation Figure 255

- Version Information** shows the device type, which can be MDR-504XX-XXXX or MDR-508XX-XXXX.
- The current firmware and MCU version is also displayed. CP3/4 version is currently not used.
- You can upgrade firmware and MCU version by browsing to your file path and clicking Upgrade.
- Configuration files can be exported. Once you click export an Internet Explorer prompt will ask to save the file. See below.
- Importing a configuration file, requires you to have a config file already stored locally and this is then sent to the MDR.

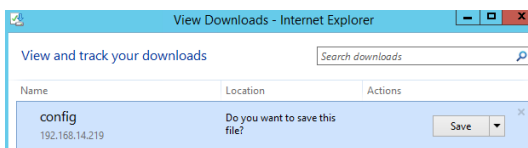

Ethernet Config File Figure 257

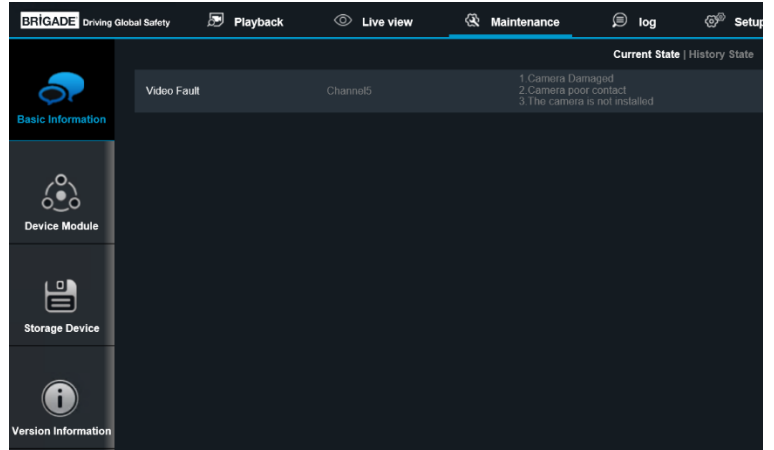

Ethernet Maintenance Figure 254

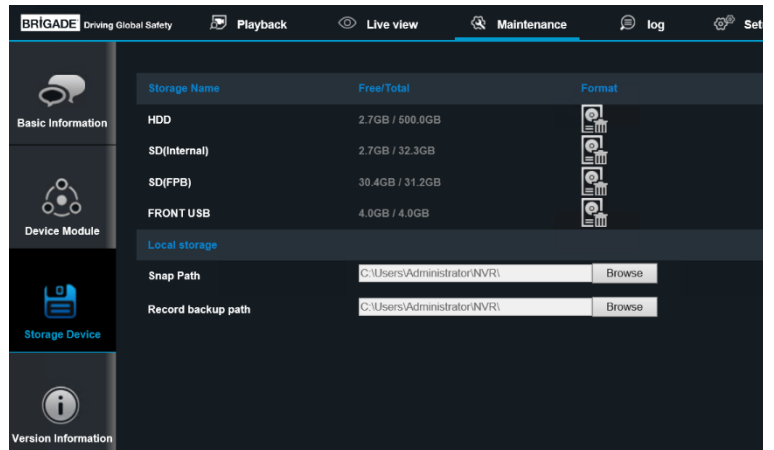

Ethernet Storage Devices Figure 256

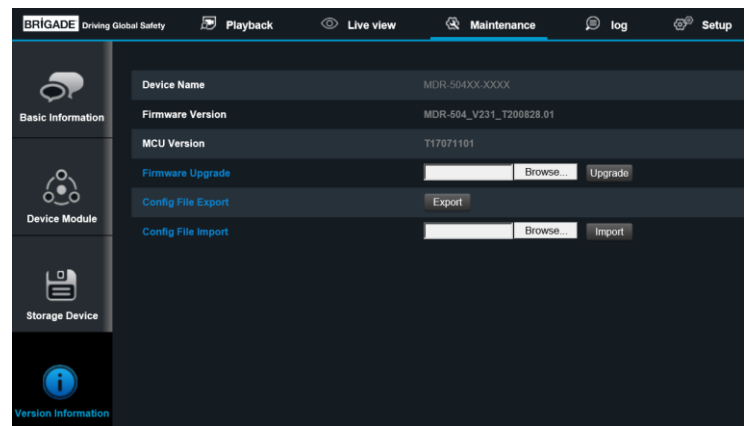

Ethernet Version Information Figure 258

11.4 Ethernet Log

- Log is used to search, display and export logs from the MDR.
- Logs can be alarm logs, operation logs or locked logs.
- Alarm logs can be filtered further by type such as: IO, Panic, Speed, Video Loss, Blind detection, Motion detection, G-Force and Geo-Fence.
- Search results are displayed below containing information such as type, date, time and details.
- Exporting log files is done by clicking Export, this will then show an Internet Explorer prompt as shown below. Click Save. By default, this will save to the following path: C:\Users\Administrator\Downloads
- Exports are stored as .txt files which can be opened by a text editor such as Notepad™.



Ethernet Log File Figure 259

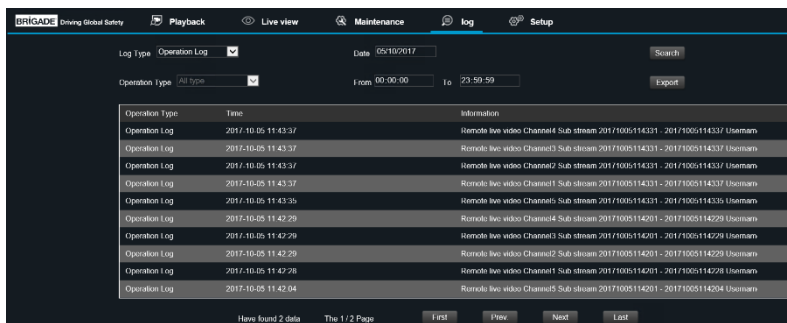

Ethernet Logs Figure 260

11.5 Ethernet Configuration

Ethernet configuration is a web version of the OSD map found on the MDR. Please refer to Chapter 7 Setup for further details. Ensure you click save after each change to ensure this gets sent to the MDR.





12 On-screen Display Map

Note: *GREEN ARIAL BLACK ITALICS* represents default settings



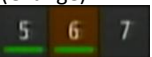

Lucida Handwriting Font represents mobile network and/or Wi-Fi menu options

12.1 Rec Search

12.1.1 Rec Search

Rec Search	
TITLE	OPTION No 1
Source	<i>HDD</i>
 Drop down option	Sub-strm SD
	Main Strm SD
Month (XXX)	 
Year (XXXX)	 
Date	Choose on calendar view (Orange) 
Next	----->

Search Options	
TITLE	OPTION No 1
Video Type	<i>ALL</i>
	Normal
	Alarm
Channel	<i>AVAILABLE INDIVIDUAL</i>
	1-4 group
	5-8 group
	9-12 group
	13-16 group
Search	----->

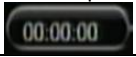
Search Results	
TITLE	OPTION No 1
Zoom Out	
Zoom In	
Earlier in day	
Later in day	
Channel options	<i>AVAILABLE INDIVIDUAL</i>
Playback Start Time	Choose time using number pad 

Export	Back		
	Start time	XX.XX.XX	
	Export ----->	PROPRIETARY DATA	Export Time
Playback (During Playback right-click removes OSD from view)	AVI data		File Size
	Show/Hide Volume menu		Remaining/Total
	Choose time using number pad		
	Volume Increase		
	Volume Decrease		
	Mute Volume		
	Next Channel		
	Previous Channel		
	Rewind x2 x4 x8 x16		
	Play / Pause		
	Fast Forward x2 x4 x8 x16		
	Slow Forward 1/2 1/4 1/8 1/16		
	Step		
Back			

12.2 SYSTEM INFO

12.2.1 Version Info

Version Info	
TITLE	OPTION No 1
Device Name	MDR-504XX-XXXX or MDR-508XX-XXXX
Serial Num	XXXXXXXXXX (10 characters)
MAC Address	XX:XX:XX:XX:XX:XX (12 characters)
Firmware Version	MDR-504_VXXX_TXXXXX.XX or MDR-508_VXXX_TXXXXX.XX
MCU Version	TXXXXXXX (9 characters)

12.2.2 Modules

12.2.2.1 Mob Net

Mob Net	
<u>TITLE</u>	<u>OPTION No 1</u>
Connection Type	GPRS/EDGE
	CDMA
	EVDO
	WCDMA
	TDSCDMA
	FDD
	TDD
Module Status (Physical State)	Detected
	Not Detected
SIM Status (Physical State)	SIM Detected
	SIM Not Detected
	SIM Available
	SIM Not Available
	SIM Busy
Dial Status	Dialled Up
	Failed Dial Up
	Unknown Error
Signal Level	 (XXdBm)
IP Address	XXX.XXX.XXX.XXX
IMEI	XXXXXXXXXXXXXXXXXX (15 characters)



12.2.2.2 Wi-Fi

Wi-Fi	
<u>TITLE</u>	<u>OPTION No 1</u>
Built-in Wi-Fi Status (Physical State)	Detected
	Not Detected
	Connecting
	Connection Failed
	Connected
	Obtaining IP Address (DHCP)
Signal Level	
IP Address	XXX.XXX.XXX.XXX
MAC Address	XX:XX:XX:XX:XX:XX (12 characters)
SmrtCntrlr Wi-Fi Status	Detected
	Not Detected
SmrtCntrlr SSID	Unique ID
SmrtCntrlr IP Address	XXX.XXX.XXX.XXX
SmrtCntrlr MAC Address	XX:XX:XX:XX:XX:XX (12 characters)

12.2.2.3 GPS

GPS	
<u>TITLE</u>	<u>OPTION No 1</u>
GPS Status (Physical State)	DETECTED
	Not Detected
GPS Satellite Count	1 - 24
Speed	MPH/ KM/H

12.2.3 Server Status

Centre Server #	
<u>TITLE</u>	<u>OPTION No 1</u> (up to 8 using   buttons)
Server Status	UNCONNECTED Connected
Network Type	Mob Net Wi-Fi Ethernet Auto-adapt
Server Protocol Type	MDR5 Maintenance
Server IP Address	XXX.XXX.XXX.XXX
Port	XXXXX (usually 5 characters, depends on port specification)

12.2.4 Environment

Environment	
<u>TITLE</u>	<u>OPTION No 1</u>
Voltage (V)	XX.XX
Device Temperature (°C)	XX.XX
HDD Heater Status	Off On
Ignition Status	Off On









12.2.5 Storage

Storage	
<u>TITLE</u>	<u>OPTION No 1</u>
Storage Type	HDD SD (Internal) SD (FPB) FRONT USB
Status	Recording Normal Failed
Free/Total (in Megabytes, Gigabytes or Terabytes)	XXX.X
Remain Time (in Days/Hours/Minutes)	X.X

12.2.6 History

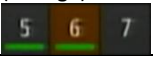
History	
<u>TITLE</u>	<u>OPTION No 1</u>
Highest Speed	xx MPH/KM/H, dd/mm/yyyy, hh:mm:ss
Total Mileage	xxxx.xxxx MILE / KM
Lowest Voltage	xx.xV, dd/mm/yyyy, hh:mm:ss
Highest Voltage	x.xV, dd/mm/yyyy, hh:mm:ss
Lowest Temperature	xx.x F/C, dd/mm/yyyy, hh:mm:ss
Highest Temperature	xx.x F/C, dd/mm/yyyy, hh:mm:ss
Highest Information Clean	

12.3 LOG SEARCH

Log Search					
TITLE	OPTION No 1				
Month					
					
Year					
					
Date	Choose on calendar view (Orange)				
					
Next	----->	Start Time	hh:mm:ss	Using Number Pad.	
		End Time	hh:mm:ss		
		Log Type	OPERATION LOG		
		Alarm Log--->		Alarm Type--->	ALL
		Locked Log			IO
		Search->			Panic Button
					Speed
					G-Force
					Video Loss
					Motion Detection
					Blind Detection
					Geo-Fence

12.4 SETUP

12.4.1 Basic Setup

12.4.1.1 Reg Info

12.4.1.1.1 Vehicle Info

Vehicle Info	
TITLE	OPTION No 1
Vehicle Reg (Shows on MDR-Dashboard)	XXXXXXXXXX (10 characters)
Vehicle Num (Shows on MDR-Dashboard)	XXXXXXXXXX (10 characters)

12.4.1.1.2 Driver Info

Driver Info	
TITLE	OPTION No 1
Driver Number (Not Shown in MDR-Dashboard)	XXXXXXXXXX (10 characters)
Driver Name (MDR-Dashboard Evidence Area)	XXXXXXXXXX (10 characters)

12.4.1.1.3 Company Info

Company Info	
TITLE	OPTION No 1
Company Name (Shows on MDR-Dashboard)	XXXXXXXXXXXXXXXXXXXX (16 characters)
Company Branch (Shows on MDR-Dashboard)	XXXXXXXXXX (8 characters)

12.4.1.2 Time Setup



12.4.1.2.1 General

General	
TITLE	OPTION No 1
Date Format	DAY/MONTH/YEAR
	MONTH/DAY/YEAR
	YEAR-MONTH-DAY
Time Format	24 HOURS
	12 Hours
Time Zone	  (GMT) DUBLIN, EDINBURGH, LONDON (GMT/±HH:MM) "City[Cities]"

12.4.1.2.2 Time Sync

Time Sync			
TITLE	OPTION No 1		
Date/Time	Choose from calendar	dd/mm/yyyy	
	Use numpad to enter time	hh:mm:ss	
GPS	ENABLED		
	Disabled		
NTP sync [?]	Enabled ----->	time.nist.gov	
	DISABLED	time.windows.com	
		time.nw.nist.gov	
		time-a.nist.gov	
		time-b.nist.gov	
	User-Defined----->	Alpha-numeric keypad	
		32 Character limit	

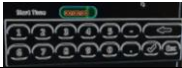
12.4.1.2.3 DST

DST			
TITLE	OPTION No 1		
Enable	ENABLED ----->	Start	MAR. Choose Calendar Month = XXX
	Disabled		1 ST ; 2 nd ; 3 RD ; 4 TH ; LAST
			SUNDAY Choose Day of Week
			02:00:00 Choose time hh:mm:ss
		End	OCT. Choose Calendar Month = XXX
			1 st , 2 nd , 3 rd , 4 th ; LAST
			SUNDAY Choose Day of Week
			02:00:00 Choose time hh:mm:ss

12.4.1.3 Power

12.4.1.3.1 On/Off

On/Off			
TITLE	OPTION No 1		
On/Off Mode [?]	IGNITION	Timer From	Enter Start Time
	Timer ----->		hh:mm:ss
	Ignition or Timer----->		Enter End Time
			hh:mm:ss
Non-stop [?]	Enabled (Disables Shutdown Delay)		
	DISABLED		
Shutdown Delay	600 SECONDS (0-86399) seconds	Using Number Pad	

12.4.1.3.2 Voltage

Voltage			
TITLE	OPTION No 1		
Low Voltage Protection	Enabled----->	Low Voltage (8~11.5) V / (20~23.5) V	11.0 V / 22.0 V
	DISABLED	Start-up Voltage (12~14) V / (24~26) V	12.0 V / 24.0 V
		Observe Time (Period observed for it to be considered a low voltage event)	300 SECONDS (0-1800) seconds
		Shutdown Delay (When MDR enters Low Voltage, this delay will countdown after observe time completes)	300 SECONDS (0-1800) seconds
		Low Volt Upload (Uploads Low Volt Information to MDR Server, requires mobile network or Wi-Fi MDR model)	Enabled
			DISABLED

12.4.1.3.3 Sleep

Sleep			
TITLE	OPTION No 1		
Sleep Mode (?)	Enabled----->	Sleep Duration	100 (0~100)Hours
		Periodic Wake-up	5 (0~720)Min
DISABLED			

12.4.1.4 User Setup

USER SETUP					
TITLE	OPTION No 1				
Menu Idle Time (Automatically Logout Period)	30 Seconds				
	1 Minute				
	3 MINUTES				
	5 Minutes				
	10 Minutes				
	Never				
Username	admin	Enabled -->	Edit ----->	Username	XXXXXXXXXX (10 characters)
	user			User Group	Admin
User Group	ADMIN			New Password	XXXXX...XXXXX (16 characters)
	Normal User			Confirm New Password	
Add (?) (Active if a maximum of 2 user accounts exist)	Username			Delete (user only)	
	User Group				
	Password				
	Confirm Password				
Check Password (?)	ENABLED				
	Disabled				

12.4.1.1 HDD Key

HDD Key			
TITLE	OPTION No 1		
Disk Drive Protection	Enabled----->	HDD Password	XXXXXXXX (8 Characters)
		OLD Password	XXXXXXXX (8 Characters)
DISABLED			

12.4.1.2 Network

12.4.1.2.1 Ethernet

Ethernet					
TITLE	OPTION No 1				
DHCP Mode (?)	Enabled----->	OBTAIN DNS AUTO			
		Use following DNS ----->	Preferred DNS Server	008.008.008.008	
			Alternate DNS Server	008.008.004.004	
Static IP	ENABLED ----->	IP Address	192.168.001.100		
	Disabled	Subnet Mask	255.255.255.000		
		Gateway	192.168.001.254		
		Use following DNS ----->	Preferred DNS Server	008.008.008.008	
			Alternate DNS Server	008.008.004.004	

12.4.1.2.2 Ports

For MDR-504 series

Ports	
TITLE	OPTION No 1
Web Port (IE access to MDR using Ethernet)	80

For MDR-508 series

Ports	
TITLE	OPTION No 1
Ethernet HTTPS (?)	ENABLED
	Disabled
	443

Web Port (IE access to MDR using Ethernet)	80 (If Ethernet HTTPS is disabled)
SAMCON TLS (?)	ENABLED
	Disabled

12.4.1.2.3 Wi-Fi

<i>Wi-Fi</i>			
<i>TITLE</i>	<i>OPTION No 1</i>		
<i>MTU</i>	1500 (1~1500)		
<i>Enable</i>	OFF		
	<i>On</i> ----->	<i>SSID</i>	XXXXX...XXXXX (32 characters)
		<i>Encryption</i> -->	None
		<i>WEP</i> ----->	<i>Password</i>
		WPA/WPA2 -->	XXXX...XXXX (32 characters)
		<i>Static IP</i>	ENABLED
		<i>Enabled</i> ---->	<i>IP Address</i>
			XXX.XXX.XXX.XXXX
			<i>Subnet Mask</i>
			XXX.XXX.XXX.XXXX
			<i>Gateway</i>
			XXX.XXX.XXX.XXXX

12.4.1.2.4 Mob Net

<i>Mob Net</i>	
<i>TITLE</i>	<i>OPTION No 1</i>
<i>Enable</i>	OFF
	<i>On</i>
<i>Server Type</i>	<i>No Service</i>
	<i>GPRS/EDGE</i>
	<i>CDMA</i>
	<i>EVDO</i>
	<i>WCDMA</i>
	<i>TDSCDMA</i>
	<i>FDD</i>
	<i>TDD</i>
<i>Network Type</i>	3G
	<i>4G</i>
	<i>Mix</i>
<i>APN</i>	XXXX...XXXX (32 characters)
<i>Username</i>	XXXX...XXXX (32 characters)
<i>Password</i>	XXXX...XXXX (32 characters)
<i>Access Number</i>	*99#
<i>Certification</i>	NONE
	<i>PAP</i>
<i>SIM Phone Num</i>	XXXX...XXXX (16 characters)

12.4.1.2.5 Server
For MDR-504 series

<i>Server</i>				
<i>TITLE</i>	<i>OPTION No-1</i>			
Centre Server	Server 1 ---->	Add/ Delete		
	Server 2 ---->	Add/ Delete		
	Server 3 ---->	Add/ Delete		
	Server 4 ---->	Add/ Delete		
	Server 5 ---->	Add/ Delete		
	Server 6 ---->	Delete		
ON	Enabled ---->	Protocol Type -->	MDR5	
			Maintenance	
	DISABLED	Network Mode -->		Ethernet
				Wi-Fi
				MOB NET
				Auto Adapt
		MDR / Main Server IP (Dependent on Protocol Type)	XXX.XXX.XXX.XXXX	
		MDR / Main Server Port (Dependent on Protocol Type)	TCP	5556
		Media / Backup Server IP (Dependent on Protocol Type)	XXX.XXX.XXX.XXXX	
		Media / Backup Server Port (Dependent on Protocol Type)	TCP	5556

For MDR-508 Series

<i>Server</i>					
<i>TITLE</i>	<i>OPTION No-1</i>				
Centre Server	SERVER 1 ---->	Add/ Delete			
	Server 2 ---->	Add/ Delete			
	Server 3 ---->	Add/ Delete			
	Server 4 ---->	Add/ Delete			
	Server 5 ---->	Add/ Delete			
	Server 6 ---->	Delete			
ON	ENABLED ---->	TLS ENABLE	ENABLED ---->	Verify Certificate	DISABLED
			Disabled		Enabled
		Protocol Type -->	MDR6		
		Network Mode -->	Ethernet		
			Wi-Fi		
			MOB NET		
			Auto Adapt		
		MDR Server IP	XXX.XXX.XXX.XXXX		
		MDR Server Port	TCP	5556 (If Server TLS is disabled)	
			TLS	6556	
		Media Server IP	XXX.XXX.XXX.XXXX		
		Media Server Port	TCP	5556 (If Server TLS is disabled)	
			TLS	6556	
	Disabled				

12.4.1.2.6 Application

FTP Server	
TITLE	OPTION No 1
FTP Enable	Disabled Enabled
Server	192.168.1.200
port	21
Username	admin
Password	XXXX...XXXX (32 characters)

12.4.2 Surveillance

12.4.2.1 Live View

12.4.2.1.1 Preview

Preview			
TITLE	OPTION No 1		
Live Audio	Enabled DISABLED		
Image Setup	Setup ----->		
	BRI (Brightness)	31 	
	CON (Contrast)	31 	
	COL (Colour)	31 	
	SAT (Saturation)	31 	
	Channel	Choose from 1 to 6 (4 channel) Choose from 1 to 16 (8 channel)	
	Mirror/Normal (Mirrors Live and Recorded Data)		
	Flip Vertical (Flips Live and Recorded Data)		
	Copy to	ALL Choose from 1 to 16	
Margins	Setup ----->	Margin-Top	20
		Margin-Bottom	20
		Margin-Left	45
		Margin-Right	45
Start-up Screen	Single		
	QUAD		
	9-Split		
Channel	Choose from 1-16	ENABLED	
		Disabled	

Copy

12.4.2.1.2 Autoscan

Autoscan			
TITLE	OPTION No 1		
Autoscan Enable (Max 32)	Enabled ----->	Add Screen ----->	Mode
	DISABLED		<table border="1"> <tr><td>Quad</td></tr> <tr><td>9-split (Only for 8CH)</td></tr> </table>
Quad			
9-split (Only for 8CH)			
			Layout
			Duration
			Mode
			Quad
			9-split (Only for 8CH)
			Layout
			Duration
		Delete	

12.4.2.1.3 Live OSD

Live OSD		
TITLE	OPTION No 1	
Date/Time	ENABLED	
	Disabled	
Vehicle Reg	Enabled	
	DISABLED	
Alarm	Enabled	
	DISABLED	
Vehicle Num	Enabled	
	DISABLED	
Recording State	ENABLED	
	Disabled	
Speed	ENABLED	
	Disabled	
GPS	Enabled	
	DISABLED	
Channel name	ENABLED	
	Enabled	
G-Force	Enabled	
	DISABLED	
Position	Setup	Drag OSD items to desired positions on screen



12.4.2.2 Record

12.4.2.2.1 General

General			
TITLE	OPTION No 1		
Video Format	PAL-AHD		
	NTSC-AHD		
HDD/SD Overwrite	By Days----->	1	1-31 Day
	BY CAPACITY		
	Never		
Locked File Retention (?)	1		1-31 Day
Alarm Pre-recording	ENABLED ----->	30 SECS	
	Disabled	1 Min	
		3 Min	
		5 Min	
		10 Min	
		15 Min	
		30 Min	
		1 Hour	
Enable Live View	ENABLED	All Channels	

12.4.2.2.2 HDD

HDD	
TITLE	OPTION No 1
Channel	Choose from 1 to 6 (4 channel) Choose from 1 to 16 (8 channel)
Channel Name	CH1-6 (4 channel) CH1-16 (8 channel)
Enable Recording	ENABLED Disabled
Resolution (options auto-adjust based on available camera inputs)	CIF WCIF HD1 WHD1 D1 WD1 720p (AHD) 1080p (AHD)
Frame Rate	20 - Choose from 1 to 30
Quality	2 - Choose from 1 (Best) to 8
Record Mode (?)	IGNITION Timer -----> Alarm
Audio	ENABLED Disabled
Record Rate (?)	I-Frame NORMAL
Alarm Quality	1 Choose from 1 (Best) to 8
Encode Mode	CBR VBR
Copy to	ALL Choose from 1 to 16

		 Delete			
	Schedule->	Choose from Sun to Sat		Start Time	hh:mm:ss
				End Time	hh:mm:ss
				Video Type->	Normal Alarm



12.4.2.2.3 SD

SD		TITLE		OPTION No 1		
Record Storage	INTERNAL SD					
	FPB SD					
Record Mode	NONE					
	SUB-STREAM ----->	Setup----->	Channel	Choose from 1 to 6 (4 channel) Choose from 1 to 16 (8 channel)		
			Enable	Disabled ENABLED		
			Audio	Disabled ENABLED		
			Resolution (options auto-adjust based on available camera inputs)	QCIF		
				CIF		
				HD1		
				D1		
				720p 1080p		
			Frame Rate	5 Choose from 1 to 30		
			Quality	2 Choose from 1 (Best) to 8		
	Copy to	ALL				
Choose from 1 to 16						
	Sub-stream CH	Choose from 1 to 6 (4 channel) Choose from 1 to 16 (8 channel)	ENABLED Disabled			
HDD (Main Stream)	Mirror CH	Choose from 1 to 6 (4 channel) Choose from 1 to 16 (8 channel)	ENABLED			
			Disabled			
Alarms (HDD)	Alarm CH	Choose from 1 to 6 (4 channel) Choose from 1 to 16 (8 channel)	ENABLED			
			Disabled			

12.4.2.2.4 Record OSD

Record OSD		TITLE		OPTION No 1	
Date/Time	ENABLED				
	Disabled				
Vehicle Reg	ENABLED				
	Disabled				
Channel Name	ENABLED				
	Disabled				
G-Force	Enabled				
	DISABLED				
Speed	ENABLED				
	Disabled				
GPS	Enabled				
	DISABLED				
Vehicle Num	Enabled				
	DISABLED				
Alarms	ENABLED				
	Disabled				
Position (?)	Setup ----->	Drag OSD items to desired positions on screen			

12.4.2.3 IPC Setup

IPC Setup							
TITLE	OPTION No 1						
1 16	Enable	Enabled -->	Search --> 	MAC Address	Enabled ----> Disabled	IP Address	
				Protocol type	MDR5 ----> ONVIF ---->	Port 9006 Port 9007	
			Network Setup -> 	Channel #			
				Protocol Type	MDR5 ONVIF		
				IP Address	xxx.xxx.xxx.xxx		
				Port	xxxxx 9006		
				Username	admin		
				Password	xxxxxxxxxxxxxxxxxxx		
			Outside	Enabled	DISABLED		
		DISABLED					
Local Address	10.100.100.	1 (Choose from 1 to 253)					
Fast Setup (IPC must be connected)	IPC ID						
	Binding CH	Choose from 1 to 16					
	IP Address						
	Port						
	Protocol Type	MDR5					
	Username						
	Password						
	Previous CH						
	Next CH						
	Save						
	Exit						

12.4.3 Events

12.4.3.1 General

12.4.3.1.1 IO

IO	
TITLE	OPTION No 1
IO Number	Choose from 1 to 8
IO Description	XXXXXXXX (8 alphanumeric characters) IO1
IO ID	Li(1), Ri(2), Rv(3), Br(4), 5, 6, 7, 8 (2 alphanumeric characters)
Copy to	ALL
	Choose from 1 to 8

12.4.3.1.2 Peripherals

Peripherals	
TITLE	OPTION No 1
Remote Panel	OFF
	On
G-Sensor	OFF
	On

12.4.3.1.3 Speed

SPEED					
TITLE	OPTION No 1				
Unit	KM/H				
	MPH				
Source	GPS				
	Speed Pulse ----->	Calibration Mode	Input Manually	Start	xx:xx:xx
			Auto Correct ---->	Finish ----->	Calculate
			Correct		
		Pulse Ratio	Per Mile / Per KM		

12.4.3.1.4 Mileage

Mileage			
TITLE	OPTION No 1		
Total Mileage	X.XXXX Mile/KM		
Actual Mileage	0 (0-1500000) Mile/KM		
Mileage Setup	Confirm	Are you sure you would like to set the mileage value?	
	Clear	Are you sure you would like to set the total mileage to zero?	

12.4.3.2 Snapshots

12.4.3.2.1 Time Snap

Time Snap					
TITLE	OPTION No 1				
Time Snap	Enabled ----->	Add ----->	New No. gets added		
	DISABLED				
No. 1 – 8 (maximum)	Start Time (Time of Day)	Using NumPad:	hh:mm:ss		
	End Time		hh:mm:ss		
	Delete	Disabled for No. 1			
	Snap Link Setup ->	Channel	Choose from 1 to 6 (4 channel) Choose from 1 to 16 (8 channel)		
		Snap Enable ----->	Enabled ----->	Resolution	CIF
			DISABLED		WCIF
		Copy to	ALL		HD1
			Choose from 1 to 16		WHD1
					D1
				WD1	
				720p	
				1080p	
				Quality	1 Choose from 1(Best) to 8
				Snap Count	1 (1~3) pcs
				Snap Interval	5 (5~3600) seconds

12.4.3.2.2 IO Snap

IO Snap		OPTION No 1			
TITLE	OPTION No 1				
Alarm Snap	Snap Link Setup----->	Channel	Choose from 1 to 6 (4 channel) Choose from 1 to 16 (8 channel)		
		Snap Enable ----->	Enabled -----> DISABLED		
		Copy to	ALL Choose from 1 to 16		
		Resolution	CIF WCIF HD1 WHD1 D1 WD1 720p 1080p		
		Quality	1 Choose from 1(Best) to 8		
		Snap Count	1 (1~3) pcs		
		Snap Interval	5 (5~3600) seconds		
		Mob App/Web Snap (IE access to MDR)	Snap Link Setup ----->	Channel	Choose from 1 to 6 (4 channel) Choose from 1 to 16 (8 channel)
				Snap Enable ----->	Enabled -----> DISABLED
				Copy to	ALL Choose from 1 to 16
		Resolution	CIF WCIF HD1 WHD1 D1 WD1 720p 1080p		
		Quality	1 Choose from 1(Best) to 8		
		Snap Count	1 (1~3) pcs		

12.4.4 Alarms

12.4.4.1 General

12.4.4.1.1 Speed Alarm

Speed Alarm			
TITLE	OPTION No 1		
Overspd	Enabled--->	Alarm Type	ALARM
	DISABLED	Event	
Trigger	Early Difference		10 MPH
	Speed		130 KM/H
			80 MPH
	Duration Time		10 (0~255) seconds
Alarm Off-Delay		10 (0~10) seconds	
Alarm Link Setup	----->	Channel	Tick 4 channels for MDR-504xx
			Tick 8 channels for MDR-508xx
		Post Record	1 Min
			3 Min
			5 Min
			10 MIN
			15 Min
			30 Min
		Lock	Enabled
			DISABLED
Alarm O/P Link	1 ----->	Alarm O/P Duration	0 (0~255) seconds
	2----->		
Channel Link	NONE		
	Single ----->	Setup ----->	Edit Screen Layout
	Quad ----->	Setup ----->	Edit Screen Layout
PB Alarm Duration			0 (0~255) seconds
Buzzer	Enabled		
	DISABLED		
Buzzer Duration	Always		
	Timer----->		10 (05 - 60 seconds)
Alarm Snap	Enabled		
	DISABLED		

12.4.4.1.2 Panic Alarm

Panic Alarm			
TITLE		OPTION No 1	
Panic Bttn	ENABLED →	Alarm Type	ALARM
	Disabled	Event	
Trigger	Activation Period	1 (1~255) seconds	
	Alarm Off-Delay	10 (0~10) seconds	
Alarm Link Setup	-----→	Channel	Tick 4 channels for MDR-504xx Tick 8 channels for MDR-508xx
		Post Record	1 Min 3 Min 5 Min 10 MIN 15 Min 30 Min
		Lock	Enabled DISABLED
Alarm O/P Link	1 -----→	Alarm O/P Duration	0 (0~255) seconds
	2 -----→		
Channel Link	NONE		
	Single -----→	Setup -----→	Edit Screen Layout
	Quad -----→	Setup -----→	Edit Screen Layout
PB Alarm Duration	20 (0~255) seconds		
Buzzer	Enabled		
	DISABLED		
Buzzer Duration	Always		
	Timer -----→	10 (05 - 60 seconds)	
Alarm Snap	Enabled		
	DISABLED		

12.4.4.1.3 IO Alarm

IO Alarm			
TITLE		OPTION No 1	
IO #	ENABLED →	Alarm Type	Alarm
	Disabled		EVENT
		Trigger	IO Set
			Alarm Off-Delay
			Low
			HIGH
			1 (0~10) seconds
		Alarm Link Setup	Channel
			Post Record
			No channel ticked for MDR-504xx
			No channel ticked for MDR-508xx
			1 Min
			3 Min
			5 Min
			10 MIN
			15 Min
			30 Min
			Lock
			Enabled
			DISABLED
		Alarm O/P Link	1 -----→
			2 -----→
			Alarm O/P Duration
			0 (0~255) seconds
		Channel Link	NONE
			Single -----→
			Quad -----→
			Setup -----→
			Edit Screen Layout
			Setup -----→
			Edit Screen Layout
		PB Alarm Duration	0 (0~255) seconds
		Buzzer	Enabled
			DISABLED
		Buzzer Duration	Always
			Timer-----→
			10 (05 - 60 seconds)
		Alarm Snap	Enabled
			DISABLED
Copy	IO #	ALL -----→	Copy
		Choose from 1 to 8 IO--→	

12.4.4.2 Video

12.4.4.2.1 Video Loss

Video Loss			
TITLE	OPTION No 1		
Video Loss	ENABLED →	Alarm Type	ALARM
	Disabled	Event	
Trigger Setup	Video Loss Setup	Channel	Tick 6 channels for MDR-504xx Tick 16 channels for MDR-508xx
		Alarm Off-Delay	5 (0~10) seconds
Alarm Link Setup	-----→	Channel	Tick 6 channels for MDR-504xx Tick 16 channels for MDR-508xx
		Post Record	1 Min 3 Min 5 Min 10 MIN 15 Min 30 Min
		Lock	Enabled DISABLED
Alarm O/P Link	1 -----→	Alarm O/P Duration	0 (0~255) seconds
	2 -----→		
Channel Link	NONE		
	Single -----→	Setup -----→	Edit Screen Layout
	Quad -----→	Setup -----→	Edit Screen Layout
PB Alarm Duration	0 (0~255) seconds		
Buzzer	ENABLED		
	Disabled		
Buzzer Duration	ALWAYS		
	Timer-----→	5 (05 - 60 seconds)	
Alarm Snap	Enabled		
	DISABLED		

12.4.4.2.2 Motion Det

Motion Det				
TITLE	OPTION No 1			
MD	Enabled--->	Alarm Type	ALARM	
	DISABLED	Event		
M.D Setup	Channel Enable (1 to 16)	Enabled ----->	Sensitivity	1 (Most)
			2	
			3	
			4	
			5	
			6	
			7	
			8	
			Area	Setup
			Activated	SHUTDOWN DELAY
	Ignition On			
	DISABLED			
	Alarm Off-Delay	10 (0~10) seconds		
Alarm Link Setup	----->	Channel	Tick 4 channels for MDR-504xx	
			Tick 8 channels for MDR-508xx	
		Post Record	1 Min	
			3 Min	
			5 Min	
			10 MIN	
15 Min				
30 Min				
Lock	Enabled			
	DISABLED			
Alarm O/P Link	1 ----->	Alarm O/P Duration	0 (0~255) seconds	
	2----->			
Channel Link	NONE			
	Single ----->	Setup ----->	Edit Screen Layout	
	Quad ----->	Setup ----->	Edit Screen Layout	
PB Alarm Duration	0 (0~255) seconds			
Buzzer	Enabled			
	DISABLED			
Buzzer Duration	Always			
	Timer----->	10 (05 - 60 seconds)		
Alarm Snap	Enabled			
	DISABLED			

12.4.4.2.3 Blind Det

Blind Det		TITLE		OPTION No 1		
BD	Enabled--->	Alarm Type	ALARM			
	DISABLED		Event			
B.D Setup	Channel (1 to 16) Enable	Enabled ----->		Sensitivity	High	
					Middle	
					Low	
				Duration Time	5 (0~255) seconds	
				Delay Time	5 (0~255) seconds	
				Alarm Off-Delay	10 (0~10) seconds	
				Disabled		
		Alarm Link Setup	----->	Channel	Tick 4 channels for MDR-504xx	
					Tick 8 channels for MDR-508xx	
				Post Record	1 Min	
3 Min						
5 Min						
10 MIN						
15 Min						
30 Min						
Lock	Enabled					
	DISABLED					
Alarm O/P Link	1 ----->	Alarm O/P Duration	0 (0~255) seconds			
	2----->					
Channel Link	NONE					
	Single ----->	Setup ----->	Edit Screen Layout			
	Quad ----->	Setup ----->	Edit Screen Layout			
PB Alarm Duration	0 (0~255) seconds					
Buzzer	Enabled					
	DISABLED					
Buzzer Duration	Always					
	Timer----->	10 (05 - 60) seconds				
Alarm Snap	Enabled					
	DISABLED					

12.4.4.3 Advanced

12.4.4.3.1 G-Force

G-Force		OPTION No 1			
G-Force	Enabled----->	Alarm Type	ALARM		
	DISABLED		Event		
Calibrate	X = 0	G-Force Trigger	Threshold Value		
	Y = 0		X	5.5 G	
	Z = 0		Y	5.5 G	
			Z	5.5 G	
			Alarm Off-Delay	10 (0~10) seconds	
		Alarm Link Setup	----->	Channel	Tick 4 channels for MDR-504xx
				Post Record	1 Min
					3 Min
					5 Min
					10 MIN
					15 Min
					30 Min
				Lock	Enabled
					DISABLED
		Alarm O/P Link	1 ----->	Alarm O/P Duration	0 (0~255) seconds
			2----->		
		Channel Link	NONE		
			Single ----->	Setup ----->	
			Quad ----->	Setup ----->	Edit Screen Layout
		PB Alarm Duration	0 (0~255) seconds		
		Buzzer	Enabled		
			DISABLED		
		Buzzer Duration	Always		
			Timer----->	10 (05 - 60 seconds)	
		Alarm Snap	Enabled		
			DISABLED		

12.4.4.3.2 Geo-Fencing

Geo-Fence			
TITLE	OPTION No 1		
Enable	ON		
	Off		
Alarm Link Setup	----->	Channel	No channel ticked for MDR-504xx
			No channel ticked for MDR-508xx
		Post Record	1 Min
			3 Min
			5 Min
			10 MIN
			15 Min
			30 Min
		Lock	Enabled
			DISABLED
Alarm O/P Link	1 ----->	Alarm O/P Duration	0 (0~255) seconds
	2 ----->	Alarm O/P Duration	0 (0~255) seconds
	Non-Stop [?]		DISABLED
			Enabled
Channel Link	NONE		
	Single ----->	Setup ----->	Edit Screen Layout
	Double ----->	Setup ----->	Edit Screen Layout
	Quad ----->	Setup ----->	Edit Screen Layout
PB Alarm Duration	0 (0~255) seconds		
Buzzer	Enabled		
	DISABLED		
Buzzer Duration	Always		
	Timer ----->		10 (05 - 60 seconds)
Alarm Snap	Enabled		
	DISABLED		

12.4.4.3.3 HDD Error

HDD/SD Error			
TITLE	OPTION No 1		
HDD/SD Error	ENABLED →	Alarm Type	ALARM
	Disabled		Event
HDD Error Setup		Alarm Off-Delay	5 (0~10) seconds
Alarm Link Setup		-----→	Channel
			Tick 4 channels for MDR-504xx Tick 8 channels for MDR-508xx
		Post Record	1 Min 3 Min 5 Min 10 MIN 15 Min 30 Min
		Lock	Enabled DISABLED
Alarm O/P Link		1 -----→	Alarm O/P Duration
		2 -----→	
			0 (0~255) seconds
Channel Link			NONE
		Single -----→	Setup -----→
		Quad -----→	Setup -----→
			Edit Screen Layout
			Edit Screen Layout
PB Alarm Duration			0 (0~255) seconds
Buzzer			ENABLED
			Disabled
Buzzer Duration			ALWAYS
		Timer-----→	10 (05 - 60 seconds)
Alarm Snap			Enabled
			Disabled

12.4.5 Maintenance

12.4.5.1 Config

12.4.5.1.1 Config

Config	
TITLE	OPTION No 1
Config File Export	Export
Config File Import	Import
Import Ethernet HTTPS Certificate and Key (in MDR-508 series)	Import
Remove Ethernet HTTPS Certificate and Key (in MDR-508 series)	Clear
Import SMACON TLS Certificate and Key (in MDR-508 series)	Import
Remove SMACON TLS Certificate and Key (in MDR-508 series)	Clear

12.4.5.1.2 Network

Network	
TITLE	OPTION No 1
Network File Export	Export
Network File Import	Import

12.4.5.1.3 Geo-Fence

Geo-Fence	
TITLE	OPTION No 1
Geo-Fence File Export	Export
Geo-Fence File Import	Import

12.4.5.2 Metadata

12.4.5.2.1 Data Export

Data Export				
TITLE	OPTION No 1			
ALL	ENABLED ----->	File Type	SNAPSHOTS	Export
	Disabled		GPS Data	
G-Force Info				
Mob Net Dial Log				
Alarm Log				
Operation Log				
Export Time	Enabled ----->	Start time	Date	yyyy-mm-dd
			Time	hh:mm:ss
	Disabled	End time	Date	yyyy-mm-dd
			Time	hh:mm:ss
	Disabled	File Type	SNAPSHOTS	Export
			GPS Data	
			G-Force Info	
			Mob Net Dial Log	
			Alarm Log	
	Operation Log			

12.4.5.3 Upgrade

Upgrade				
TITLE	OPTION No 1			
FMW/MCU Upgrade	Upgrade	Are you sure you would like to Upgrade?		
IPC Upgrade (IPC must be connected)	Upgrade	All	Enabled	Upgrade
			Disabled	
		Choose from the available IP Cameras	Enabled	Upgrade
			Disabled	

12.4.5.4 Storage

Storage					
TITLE	OPTION No 1				
Storage Type	HDD				
	SD (Internal)				
	FPB SD				
	FRONT USB				
Free/Total	XXXX.X G				
Format	HDD	Are you sure you would like to Format?			
	SD (Internal)				
	FPB SD				
FRONT USB	Format type	FAT32	Are you sure you would like to Format FRONT USB?		
		MDR5	Less than 4GB	Capacity is less than 4GB, not formatted into MDR5 system!	
	Greater than 4GB		Are you sure you would like to Format FRONT USB?		

12.4.5.5 Reset

Reset		
TITLE	OPTION No 1	
Factory Settings	Restore	Are you sure you would like to Restore Factory Default Settings?
System Restart	Restart	Are you sure you would like to Restart?

12.4.5.6 Hardware

Hardware						
TITLE	OPTION No 1					
Hardware Config Import	Import					
Hardware Config Export	Export					
General System Check	Check	General Check Results				
Super System Check	Login	Please Enter the Super System Password				
		Password	Login	Super Check Results	Edit Password	Current Password
			Cancel			New Password
						Re-enter Password
					Create HW Config	Created HW Config Successfully
					Exit	

12.4.5.7 Certificate (in MDR-508 series)



Certificate		
TITLE	OPTION No 1	
Trusted Root Certificates ?	Import	
Remove ALL Root Certificates	Remove	Are you sure you want to remove ALL root certificates? Warning: After removing, server connections will fail when verify certificate is enabled. Because there is no root certificate to check against.
Certificate Revocation Lists ?	Import	
Remove CRLs	Remove	Are you sure you want to remove ALL CRLs? Warning: After removing, certificate revocation checking will be skipped when verify certificate is enabled. Because there is no CRL to check against.

12.5 LOGOUT `

12.5.1 Logout Prompt

Logout Prompt	
TITLE	OPTION No 1
Are you sure you would like to Logout?	OK
	Cancel

13 Help Button

Main Menu	Sub Menu	Page	Tab Menu	Title	Open	Text	Close
SYSTEM INFO	-	Version Info	-	Serial Num		For Mobile Network / Wi-Fi MDR models: Serial Numbers is shown under MDR	
SETUP	Basic Setup	Time Setup	Time Sync	NTP sync		Only for Mobile network or Wi-Fi MDR units.	
SETUP	Basic Setup	Power	On/Off	On/Off Mode		Timer mode must not be used for extended periods of time - this will damage your vehicle's battery.	
SETUP	Basic Setup	Power	On/Off	Non-stop		Non - stop allows the MDR to record infinitely. Enabling this will disable Shutdown Delay Warning. Using the MDR for prolonged periods of time without ignition (vehicle running) can drain the vehicle's battery.	
SETUP	Basic Setup	Power	Sleep	Sleep Mode		Enable sleep mode to allow MDR automatic wake up after a certain period of time to support MDR-Dashboard client auto-download feature. Sleep Duration: Sleep duration before MDR completely shutdown after ignition off. Periodic Wake-up: After entered minutes of sleep, MDR will turn on automatically to start auto-download task.	
SETUP	Basic Setup	User Setup	-	Check Password		By ticking this box the MDR will check the complexity of your login password. If the password is default or too simple a window will pop up after the MDR has started up and will ask you to change its password to be more complex. This will show every time the MDR starts up, a mouse is required to remove the notification each time.	
SETUP	Basic Setup	Network	Ethernet	DHCP Mode		Automatically obtains IP address from network.	
SETUP	Basic Setup	Network	Ports	Ethernet HTTPS		If enabled, the device will use HTTPS to communicate with the browser when accessing the Ethernet page.	
SETUP	Basic Setup	Network	Ports	SMACON TLS		If enabled, TLS encrypted communication will be used when the user accesses the device via the Smartcontroller APP.	
SETUP	Basic Setup	Network	Server	Verify Certificate		If verify certificate is enabled, the device will check whether the server certificate is trusted when connecting to the server. If the server certificate is not trusted or expires, the device will disconnect from the server.	
SETUP	Surveillance	Record	General	Locked File Retention		This will ensure that alarms that are set as locked files will be stored for this time period. Locked files are automatically deleted once this period is over, regardless of remaining storage capacity.	
SETUP	Surveillance	Record	HDD	Record Mode		Timer prevents an MDR from turning Off - higher priority than on/off timer. This timer CANNOT control when an MDR turns ON.	
SETUP	Surveillance	Record	HDD	Record Rate		I.Frame MDR will record using one frame per second in order to save storage, but once an alarm is triggered, the MDR will record with the current frame rate. Normal MDR will record using the correct frame rate.	
SETUP	Surveillance	Record	Record OSD	Position		Choice of a maximum of 6 options.	
SETUP	Alarms	Advanced	Geo-Fence	Alarm Link Setup		Non-Stop allows the sensor output infinitely as long as the MDR is within the Geo-Fence region. Note:	

SETUP	Maintenance	Certificate	Trusted Root Certificates
SETUP	Maintenance	Certificate	Certificate Revocation Lists

the region can be set in MDR-Dashboard 5.0 software.
The root certificates are used to verify whether the TLS connection between the device and the server is trusted. The certificate format supports X.509.
The CRL (Certificate Revocation List) is used to check whether a certificate is valid. The CRL format supports X.509.

14 Mounting Dimensions

14.1 MDR-504XX-X-XX-XXX(XX)

For mounting centre holes please refer to MDR-BKT-01 drawing.

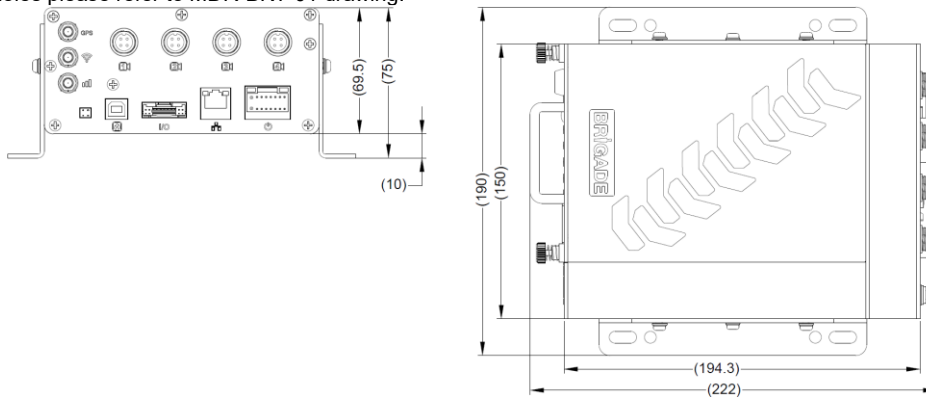

<u>Bracket Position</u>	<u>MDR height from ground</u>
1 (highest on bracket)	29 mm
2	20 mm
3	12.5 mm
4 (lowest on bracket)	4.5 mm

14.2 MDR-508XX-X-XX-XXX(XX)

For mounting centre holes please refer to MDR-BKT-01 drawing.

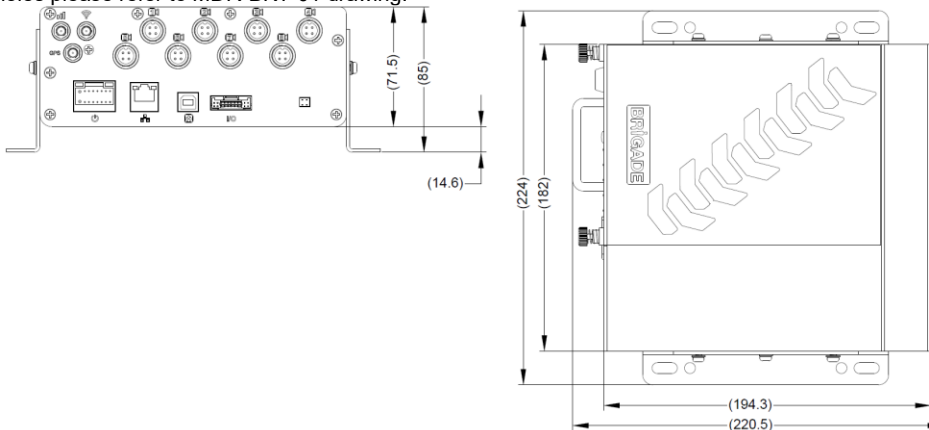

<u>Bracket Position</u>	<u>MDR height from ground</u>
1 (highest on bracket)	30 mm
2	28 mm
3	14 mm
4 (lowest on bracket)	6 mm

15 Appendices

15.1 Video Quality Table

Using Brigade's Resource calculator, the below tables have been compiled. Please note the following:

- The values below are for reference only
- Streaming bandwidth can vary considerably according to the level of variations in the image. Static images are more efficiently compressed than dynamic ones
- Frame rates are assumed to be set to maximum which is 25fps for PAL and 30fps for NTSC

Quality level	1 (Highest)	2	3	4	5	6	7	8 (Lowest)	
Video Streaming Data Rate (Kbps) depending on resolution	1080P (AHD)	8192	6390	5505	4068	3712	2818	1919	1024
	720P (AHD)	6144	4800	4128	3456	2784	2112	1440	768
	D1	2048	1536	1280	1024	900	800	720	640
	HD1	1536	1280	1024	768	640	560	500	450
	CIF (Lowest)	1024	768	640	512	440	350	312	280

15.2 Normal / Alarm Recording Parameters

Warning: The values shown below are for reference only.

For typical recording sizes for a one-hour duration and HDD recording times in hours versus storage capacity, please use the link below:

<https://brigade-electronics.com/mdr-storage-calculator/>

A screenshot for 4 channels of the Mobile Digital Recorder Storage Calculator is shown below (using default settings):

BRIGADE								Add Channel
Total recording data per hour:		2.32 GB						
Number	Resolution	Video Format	Quality	Frame Rate(1-30)	Bit Rate(Kbps)	Recording data per hour	Remove Channel	
1	D1 P704*576 / N704*480	PAL	2	20	1536	594 MB	Remove Channel	
2	D1 P704*576 / N704*480	PAL	2	20	1536	594 MB	Remove Channel	
3	D1 P704*576 / N704*480	PAL	2	20	1536	594 MB	Remove Channel	
4	D1 P704*576 / N704*480	PAL	2	20	1536	594 MB	Remove Channel	

Storage Capacity:	500
Total recordable hours	215

15.3 Sub-Stream Recording Parameters

The following table is valid for both the MDR-504XX-X-XX-XXX(XX) using all 4 channels and MDR-508XX-X-XX-XXX(XX) using all 8 channels. It illustrates approximate SD recording times in hours at CIF resolution and different frame rates. Ranges of frame rates are controlled by the sub-stream bandwidth.

Bandwidth		4096 Kbps	3200 Kbps	1500 Kbps	500 Kbps
Recording Time onto SD (hours) depending on frame rate	25 fps (fastest)	12			
	20 fps	15			
	15 fps		20		
	10 fps		29		
	5 fps				60
	1 fps (slowest)				305

Note: Sub-stream and Mainstream recording onto SD card has resource limitations, the maximum bitrate is 12Mbps.

Please calculate using the following steps:

PAL: Actual Bit Rate = Actual frame rate / 25 * Bit Rate (Full frame rate) * transfer ratio

Transfer Ratio: Frame rate (1-5):1.4; Frame rate (6-11):1.3; Frame rate (12-17):1.2; Frame rate (18-22):1.1; Frame rate (23-25):1.0

NTSC: Actual Bit Rate = Actual frame rate / 30 * Bit Rate (Full frame rate) * transfer ratio

Transfer Ratio: Frame rate (1-6):1.4; Frame rate (7-14):1.3; Frame rate (15-21):1.2; Frame rate (22-27):1.1; Frame rate (28-30):1.0

15.4 User Log Description

Reason	Example	Description	
MDR Ignition	08:48:16 Power on	MDR powers on	
	10:06:53 Ignition off		
	10:06:57 The host power down	MDR shuts down	
	10:10:19 Low Voltage Protect reboot down		
	15:28:51 Restart	Auto Restart	
	22:30:55 Upgrade		
	22:33:43 Host upgrade reboot	Reboot after upgrade	
MDR Info	08:48:23 Firmware version:MDR-504_V231_T170401.01 MCU version:T17010901		
MDR Recording	08:48:25 Chn1 Main Record Open		
	08:48:25 Chn2 Main Record Open		
	08:48:25 Chn1 Sub Record Open		
	08:48:25 Chn2 Sub Record Open		
	11:04:45 Chn3 Main Record Close		
	11:04:45 Chn3 Sub Record Close		
MDR Login	08:49:27 Local user login Device login	Means use device to operate	
	08:56:21 Local user logout Device login		
MDR Setup Changed	08:50:53 Rec Search Device login		
	08:50:15 Save configuration Basic Setup->Network->Server Device login		
	09:10:07 Save configuration Alarms->General->IO Alarm Device login		
	10:05:13 Save configuration Events->General->Peripherals Device login		
	10:12:37 Save configuration Alarms->General->Panic Alarm Device login		
	10:30:13 Local backup Device login Video name:20170512000000 – 20170512000025	Export Footage	
	10:34:59 Save configuration Alarms->Advanced->G-Force Device login		
	10:35:34 Save configuration Events->Snapshots->IO Snap Device login		
	11:42:13 Save configuration Basic Setup->Power->Voltage Device login		
	14:25:51 Log Search Device login		
	15:21:40 Local playback Device login Video name:20170512120935 - 20170512120936		
	15:28:50 Save configuration Video Format Device login	Change from PAL to NTSC or vice versa	
	15:35:00 Reset settings Device login		
	00:47:21 Format disk Device login		
	03:58:23 Modify recording settings Device login Channel:1 Main stream:D1->720P Frame rate:25->30		
	03:23:22 IPC05 online	When you connect an IPC	
	18:54:21 Timer off	Ignition mode: Timer, and time up	
	Alarms	11:04:41 Chn3 Video Loss	
		11:35:19 The host power down	When voltage goes too low
		11:43:30 Low voltage off	Voltage goes up at normal level and cancel the low voltage alarm
08:44:52 08:45:04 Channel1motion			
09:10:07 09:11:15 IO1 Li			
10:04:55 10:05:05 ACC Y Direction			
11:31:54 11:32:06 panel			
11:42:54 11:42:54 Low Voltage alarm			
MDR-Dashboard 5.0 Remote Control	08:53:36 Remote live video Channel1Sub-stream 20170512085311 – 20170512085336		
	08:52:23 Download record Remote user login 20170511230000 – 20170511230100	Remote Operation	
	09:02:25 Auto download sleep	When multiple tasks are downloading, some devices need to wait	
	03:03:38 Enter Polygon Area [(1)]	Geo-fence function	
	03:45:22 Exit Polygon Area [(1)]	Geo-fence function	

15.5 MDR-Dashboard 5.0 Silent Installation

MDD-Dashboard 5.0 supports silent installation using PowerShell switches. Follow the steps below to complete a silent installation:

Copy the installer to a directory, such as: C:\install\MDR-Dashboard_5.0_2.2.2.0.22.exe

Enter the PowerShell window

Run the command: C:\install\MDR-Dashboard_5.0_2.2.2.0.22.exe /VERYSILENT /SP-

You can also put the command in the batch file intall.bat and double-click install.bat to run it. An example is shown below

```
ECHO.
ECHO Installing MDR-Dashboard 5.0
ECHO Please wait...
start /wait %systemdrive%\install\MDR-Dashboard_5.0_2.2.2.0.22.exe /VERYSILENT /SP-
ECHO
ECHO Killing MDR-Dashboard_5.0_2.2.2.0.22.exe process
taskkill.exe /F /IM MDR-Dashboard_5.0_2.2.2.0.22.exe
ECHO
```

15.6 MDR-Dashboard 5.0 Additional PowerShell Switches

SP-	Disables the "This will install... Do you wish to continue?" prompt at the beginning of the setup. This will have no effect if the DisableStartupPrompt [Setup] section directive was set to yes.
-----	---

/SILENT, /VERYSILENT	Instructs Setup to be silent or very silent. When Setup is silent the wizard and the background window are not displayed but the installation progress window is. When a setup is very silent this installation progress window is not displayed. Other prompts display as normal, for example error messages during installation are displayed and the startup prompt is (if you haven't disabled it with DisableStartupPrompt or the "/SP-" command line option explained above) If a restart is necessary and the "/NORESTART" command isn't used (see below) and Setup is silent, it will display a Reboot now? messagebox. If it is very silent it will reboot without prompting.
/NORESTART	Instructs Setup not to reboot even if it is necessary.
/LOADINF="filename"	Instructs Setup to load the settings from the specified file after having checked the command line. This file can be prepared
using the "/SAVEINF=" command as explained below. /SAVEINF="filename"	Instructs Setup to save installation settings to the specified file.
/DIR="x:\dirname"	Overrides the default directory name displayed on the Select Destination Directory wizard page. A fully qualified pathname must be specified. If the [Setup] section directive DisableDirPage was set to yes, this command line parameter is ignored.
/GROUP="folder name"	Overrides the default folder name displayed on the Select Start Menu Folder wizard page. If the [Setup] section directive DisableProgramGroupPage was set to yes, this command line parameter is ignored.
/NOICONS	Instructs Setup to initially disable the Don't create any icons check box on the Select Start Menu Folder wizard page.
/COMPONENTS="comma separated list of component names"	Overrides the default components settings. Using this command line parameter causes Setup to automatically select a custom

15.7 Events Table

The following table illustrates the type of events recorded. This is illustrated in the event list search of the MDR and MDR-Dashboard 5.0.

Event Type	Event Name	Description
Video Loss	VL	Video loss alarm (e.g. the camera has been either deliberately or inadvertently disconnected).
Blind Detection	BD	Blind camera alarm (e.g. the camera has been intentionally obstructed or a large object is obstructing the entire view).
Motion Detection	MD	Motion detection for video capturing when vehicles are unattended.
Triggers	Name of the Trigger (e.g. IO1, IO2 etc. or PB for Panic Button)	GPIO (general purpose input/output) trigger sensor alarm.
Speed Alarm	H-Speed	Overspeed can be flagged and recorded.
G-Force	G-Force	Excessive G-Force can be flagged and recorded.

16 Testing and Maintenance

16.1 Operator Instructions

This information is addressed to the operator of the vehicle where a Brigade MDR 500 Series System is installed:

- 1) The Brigade MDR 500 Series is intended to be used as a mobile digital recorder. Drivers and operators should not interact with the MDR setup menu. The remote control should be strictly used by technically trained operators when the vehicle is stationary.
- 2) Testing and inspection of the system should be carried out in accordance with this manual. The driver or operator is responsible for ensuring the Brigade MDR 500 Series System is working as intended.
- 3) Operators using this equipment are strongly recommended to check the system's operation at the beginning of every shift.
- 4) Improved safety can be achieved when used in conjunction with Brigade's camera-monitor systems. This may allow triggering camera views and providing additional vehicle information during manoeuvring. It is necessary to read, understand and follow all instructions received with the Brigade MDR 500 Series System.
- 5) The Brigade MDR 500 Series System for digital recording is intended for use on commercial vehicles and machinery equipment. Correct installation of the system requires a good understanding of vehicle electrical systems and procedures along with a proficiency in installation.
- 6) Keep these instructions in a safe place and refer to them when maintaining and/or reinstalling the product.

16.2 Maintenance and Testing

This information is addressed to the operator for maintenance and testing of a vehicle with the Brigade MDR 500 Series System installed. This is also to familiarise the operator with the features and behaviour of the system. More frequent inspections should be performed in cases where:

- The vehicle is operating in a particularly dirty or harsh environment.
- The operator has reason to suspect the system is not working or has been damaged.

Procedure:

- 1) Clean the camera lens and housing of any accumulation of dirt, mud, snow, ice or any other debris.
- 2) Visually inspect the cameras and MDR unit and verify that they are securely attached to the vehicle and are not damaged.
- 3) Visually inspect the system's cables and verify that they are properly secured and not damaged.
- 4) Ensure the area in front of the cameras is clear of obstacles and has the right coverage area to view objects.

If any of the following tests fail, follow the appropriate sections of this instruction guide or contact Brigade if still in doubt.

- 5) Activate the Brigade MDR 500 Series System and verify the LEDs (on the MDR unit front) are illuminated, it should take approximately 50 seconds for HDD recordings to start after a file-system check.
- 6) This test can only be performed when the MDR video output is displayed on a Brigade monitor. Ensure that both the SD card and HDD are recording. Recording is shown with an SD card symbol and HDD symbol.
- 7) Other tests can be performed depending on the configuration. For instance, if Video Loss is activated, any disconnected or malfunctioning camera is detected.
- 8) Sensor trigger activation can also be diagnosed. For instance, if a trigger is setup to turn a channel on full screen or set an alarm. This will be identified by the channel occupying the full screen or a red-letter A (if a Brigade monitor is connected).
- 9) GPS, G-Sensor, Supply Voltage and Heater functioning can be accessing SYS INFO using the mouse (if a Brigade monitor is connected).

17 General Antennae Guidelines

- (a) Ensure that the cable is:
 - properly secured but ensure that the cable is not strained or distorted
 - routed in such a way as to avoid sharp bends
 - not run in parallel with vehicle wiring wherever possible
 - routed as far away as possible from any electronic module
- (b) Excess coaxial cable should not be coiled up as this may affect the tuning of the antenna as well as producing electrical interference. Excess cable should be laid out over a larger area to avoid potential coiling.
- (c) Before connection to the equipment the antenna system should be DC tested at the equipment end of the coaxial cable for continuity and to ensure there is no short circuit.
- (d) Antenna positions should be planned to achieve best separation between antennas while maintaining a suitably sized ground plane for each one. Each antenna should be separated by at least 50cm where possible. This includes antenna already fitted to the vehicle, for example; radio, phone and GPS devices.
- (e) Record and playback a short section to check recordings do not have or cause interference. EMC issues may cause interference to in-car entertainment equipment or other vehicle electrical equipment. Also, the antenna may pick up noise received from the vehicle or other fitted role equipment such as light bars, GPS processors and other digital (computing) equipment and present it to the radio equipment as interference. Repositioning may be required.

18 Troubleshooting

18.1 MDR Unit

Scenario	Detection	Resolution
Loss of recording data	<ol style="list-style-type: none"> 1. Error light will be visible on the MDR unit LED panel 2. Error light will be shown on the Remote panel 3. If the sound buzzer is activated or a sound buzzer is connected to one of the trigger outputs, an audible alarm can alert drivers 	<ol style="list-style-type: none"> 1. SD card is used to recover data – see the manual for recording options 2. Require the LED panel of the MDR or a remote panel to always be visible to driver 3. The sound buzzer should be activated and configured to alert drivers to errors.
System Power loss	<ol style="list-style-type: none"> 1. Error light will be visible on the MDR unit LED panel and power LED will turn off 	<ol style="list-style-type: none"> 1. Vehicle Battery should be replaced if it is suspected of malfunctioning 2. Low Voltage protection feature should be turned on 3. Fuses may be blown and may need to be replaced
Data Corruption due to Power loss	<ol style="list-style-type: none"> 1. Error light will be visible on the MDR unit LED panel and power LED will turn off 	<ol style="list-style-type: none"> 1. MDR is powered for few minutes after power loss to enable closure of recording files
Video Loss	<ol style="list-style-type: none"> 1. Video loss LED will turn on which is found on the MDR and the Remote panel 2. If the sound buzzer is activated or a sound buzzer is connected to one of the trigger outputs, an audible alarm can alert drivers 	<ol style="list-style-type: none"> 1. Cables if possible should not be installed in an area where these can be tampered with 2. Ensure cable connectors are secure before driving
No recording on SD or HDD	<ol style="list-style-type: none"> 1. Error light will be visible on the MDR unit LED panel 2. Error light will be shown on the Remote panel 3. If the sound buzzer is activated or a sound buzzer is connected to one of the trigger outputs, an audible alarm can alert drivers 	<ol style="list-style-type: none"> 1. Ensure that the Overwrite feature is turned on 2. Install 1 TB HDD or 256GB SD card
MCU failure	<ol style="list-style-type: none"> 1. Visible Physical Damage and unable to connect on PC 	<ol style="list-style-type: none"> 1. Retain a backup MCU for a vehicle 2. Ensure supplied USB cable is used 3. Ensure PC is fully up to date with Windows updates and drivers are installed
Failure due to Environment	<ol style="list-style-type: none"> 1. Error light will be visible on the MDR unit LED panel 2. Error light will be shown on the Remote panel 3. HDD recording cannot begin (HDD LED not ON) 	<ol style="list-style-type: none"> 1. Driver should wait a few minutes for the internal heater to heat the HDD to above 0°C – this will then start to record
Docking Station Failure	<ol style="list-style-type: none"> 1. No visible power LED is on 	<ol style="list-style-type: none"> 1. Ensure the MCU KEY is locked 2. Ensure that wires that are being used are protected by heat shrink
HDD inconsistent functionality (HDD Repair)	<ol style="list-style-type: none"> 1. Error light will be visible on the MDR unit LED panel 2. Error light will be shown on the Remote panel 	<ol style="list-style-type: none"> 1. Customers must follow the MCU removal procedure as stipulated in the manual

18.2 MDR Fireproof Box

- When you connect a Fireproof box to the MDR. This needs to be enabled in the OSD. Go to Surveillance > Record > SD > FPB SD.
- The MDR may restart to engage this new hardware device.
- All new fireproof boxes must be formatted before use.
- Please follow the below steps to do this:
 - Format as FAT32 first so the correct storage capacity displays
 - Then format as MDR5 so the MDR can record to this storage
- The process above will never have to be repeated
- Finally confirm storage under system information, it should show under SD(FPB) as 31.2GB.



FPB SD Enable Figure 261

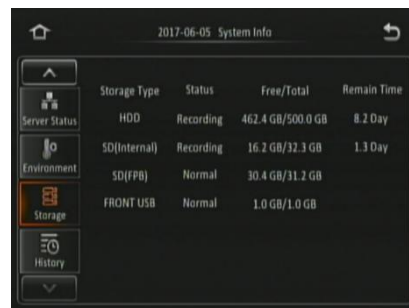

FPB SD Storage Capacity Figure 262

19 Specifications

Features

Video System	PAL/NTSC/AHD
Video Input	4x Channels - Select Connector 2x Channels for IP cameras via Ethernet Connector, requires PON switch / 8x Channels - Select Connector 8x Channels for IP cameras via Ethernet Connector, requires PON switch
Video Output	1x Channel - Select Connector
Video Compression	H.264
Setup or Control	USB Mouse and PC (Ethernet Menu)
Display Split	Single, Quad or 9-Split
Audio Input	4 Channels - Select Connector (if frame rate set above 6fps) 2x Channels for IP cameras via Ethernet Connector, requires PON switch / 8 Channels - Select Connector (if frame rate set above 6fps) 8x Channels for IP cameras via Ethernet Connector, requires PON switch
Audio Output	1x Channel - Select Connector
Audio Compression	ADPCM
On-Screen Display	GPS information, alarm, temperature, acceleration, voltage, firmware version, MCU version, device information, network information, storage information
Operation Interface	OSD Graphical User Interface
Image View	Normal View, Mirror View or Flip Vertical per channel
Installation Direction	Any mounting direction (internal HDD anti-vibration mount)
Image Frame Rate Minimum - Maximum	1-25 FPS (PAL); 1-30 FPS (NTSC); 1-30 FPS (AHD); 1-30 (IP Camera dependent)
Image Resolution	PAL: WD1 (960x576), D1 (704x576), WHD1 (960x288), HD1 (704x288), WCIF (960x288), CIF (352x288) NTSC: WD1 (960x480), D1 (704x480), WHD1 (960x240), HD1 (704x240), WCIF (960x240), CIF (352x240) AHD: HD (1280x720), FULL HD (1920x1080) IP Camera: HD (1280x720), FULL HD (1920x1080) configurable for each channel
ipImage Quality	1-8 Adjustable Levels (1 is the Best)
Recording Mode	Normal, Alarm, Timer
Pre-alarm Recording	Range 30 seconds to 60 minutes
Post-alarm Recording	Range 1 to 30 minutes
Shut-down delay (Post-recording)	Range 0 seconds to non-stop
Mirror Recording	Yes, on SD Card
Playback of Recordings	1 Channel at a time using MDR video output to monitor 1-6 or 1-16 Channels using MDR-Dashboard 5.0 / MDR-Player 5.0 / PC via browser (Ethernet)
File Search Mode Options via OSD	Date/Time/Channel/File Type
Built in Heater	At -25°C HDD records after approx. 15 minutes At -25°C SD records after approx. 4 minutes Threshold temperature is 0°C for heater to turn ON, heater turns OFF at 5°C
Built-in GPS	GPS location tracking, speed detection and sync clock
Built-in Buzzer	Yes, configurable for all alarms
Built in G-Sensor	Yes, threshold is configurable
Storage Capacity	500GB / 1TB / 2TB CMR HDD / SSD (2TB maximum) 32GB / 64GB Class 10 SD Card (256GB maximum)
Storage Capacity (Hours of Recordings)	Best - 142 hours (Quality 1; Res. D1; 25/30fps) Typical - 1164 hours (Quality 8, Res. CIF; 25/30fps) Longest - 1862 hours (Quality 8, Res. CIF, 1fps)
Access Mode	Password Protected Access and 2x User Groups (Admin and Normal)
Languages	OSD, Ethernet Menu, MDR-Dashboard 5.0, MDR-Player 5.0, MDR Server 5.0 and MDR 5.0 Apps in English, Russian, Portuguese, Polish, Dutch, Italian, French, Spanish, German
MDR Status/Diagnostic LEDs (Front of the Unit)	Power, HDD Recording, HDD State, SD State, GPS, Video Loss, Alarms, Errors, Network and Heater State

Network Interface

Mobile Standards	Worldwide Excluding North America Models: 2G/3G/4G [Variants that contain "G" or "GW" in its model number] North American Models: 3G/4G [Variants that contain "G" or "GW" in its model number]
Mobile Operating Bands	Worldwide Excluding North America Models: 4G (FDD LTE): B1,B3,B7,B8,B20,B28A, all bands with receive diversity 3G (WCDMA/HSUPA/DC-HSPA+): B1,B8, all bands with receive diversity 2G (GPRS/GSM/EDGE): 900/1800 MHz [Variants that contain "G" or "GW" in its model number] North American Models: 4G (FDD LTE): B2,B4,B5,B12, all bands with MIMO and diversity 3G (WCDMA/HSPA+/HSPA/DC-HSPA+): B2,B4,B5, all bands with diversity [Variants that contain "G" or "GW" in its model number]
Mobile Data Services	Worldwide Excluding North America Models: GPRS: UL 85.6 kbit/s; DL 107 kbit/s EDGE: UL 236.8 kbit/s; DL 296 kbit/s WCDMA: UL 384 kbit/s; DL 384 kbit/s HSUPA: UL 5.76 Mbit/s DC-HSPA: DL 42 Mbit/s LTE FDD: UL 50 Mbit/s; DL 150 Mbit/s [Variants that contain "G" or "GW" in its model number] North American Models: WCDMA PS: UL 384 kbit/s; DL 384 kbit/s HSPA+, DC-HSPA+, HSPA LTE FDD: UL 50 Mbit/s; DL 150 Mbit/s @1.4, 3, 5, 10, 15, 20MHz BW cat4 [Variants that contain "G" or "GW" in its model number]
SIM Card Type	DATA ONLY [Variants that contain "G" or "GW" in its model number]
SIM Card Size	Standard [Variants that contain "G" or "GW" in its model number]
Wireless Standard	802.11n/g/b [Variants that contain "W" or "GW" in its model number]
Maximum Wireless Transmission Rate	72.2 Mbps for 20 MHz and 150 Mbps for 40 MHz channel operations [Variants that contain "W" or "GW" in its model number]
Wireless Security Standards	WEP 64/128, WPA, WPA2, TKIP, AES, WAPI [Variants that contain "W" or "GW" in its model number]

Windows Software

File Download via	USB 3.0 (Mobile Caddy Unit) using MDR-Dashboard 5.0 and USB 2.0 Flash drive with FAT32 format (Docking Station)
Image Search by time/date	MDR-Dashboard 5.0
Review Alarm Events	MDR-Dashboard 5.0
View Exported Recordings	MDR-Player 5.0
Mobile network and Wi-Fi Server Functionality	MDR Server 5.0

Mobile Applications

MDR 5.0 Android Operating System	MDR 5.0
MDR 5.0 iOS Operating System	MDR 5.0

Connections/Interfaces

USB-A Interface Front Docking Station	USB 2.0 x 1 used for exporting, upgrading and configurations USB Flash Drives: Maximum 16GB, 5V and 500mA 3.5" external desktop HDDs with its own power supply: Maximum 1TB
USB-B Interface Rear Docking Station	USB 2.0 x 1 - Connect to Fireproof Box
USB-B Interface Mobile Caddy Unit	USB 2.0 x 1 - Connect to PC
Serial Interface	RS485 x 2 Connector (G-Sensor and Remote Panel) via multi-pin connector
Network Ethernet	RJ45 port (10/100M) for MDR-504 Series RJ45 port (10/100/1000M) for MDR-508 Series (For IP camera PON switch or MDR configuration using Ethernet Menu on PC)
AV Output	1x Select type connector for monitor
AV Input	4x Select type connector for cameras (MDR-504 Series) 8x Select type connector for cameras (MDR-508 Series)
Input/Output, Power Output	8x Trigger Inputs, 2x Outputs, 1x 12V OUT, 1x GND, 1x Speed Signal and 1x Speed GND via multi-pin connector
GPS	1x SMA Connector to external antenna
Mobile Network	1x SMA Connector to external antenna
Wi-Fi	1x SMA Connector to external antenna
Power Input	Tail cable via multi-pin connector

Mechanical Specification

Dimensions typ. Assembly (W x H x D) including brackets	190mm x 75mm x 222mm for MDR-504 Series 224mm x 85mm x 220.5mm for MDR-508 Series
Weight (Docking Station and Mobile Caddy Unit)	2.2kg for MDR-504XX Series 2.8kg for MDR-508XX Series

Materials

Finish or Coating of Outside Surface	Gunmetal Grey (Pantone 425C)
Material of Control Unit	Extruded Aluminium, Oil Painted (Pantone 425C)
Material of Mobile Caddy Unit	Extruded Aluminium Alloy, Oil Painted (Pantone 425C)
Material of Bracket	Aluminium, Oil Painted (Pantone 425C)

Electrical Interface

Operating Voltage (min. / typ. / max.)	8.5V /12V / 32V (without any cameras and any accessories)
Quiescent Current	At 12V: 0.9mA, At 24V: 1.25mA [MDR-504 Series] At 12V: 1.78mA, At 24V: 2.28mA [MDR-508 Series]
Current Consumption (min. / typ. / max. per mode)	MDR-504 Variants: 300mA (stable @ 24V) / 600mA (stable @ 12V) (without cameras, camera heaters off and MCU heater off) 500mA (stable @ 24V) / 1A (stable @ 12V) (with cameras, camera heaters off and MCU heater off) 2.5A (stable @ 24V) / 5A (stable @ 12V) (with cameras, camera heaters on and MCU heater on) MDR-508 Variants: 1A (stable @ 24V) / 2A (stable @ 12V) (with cameras, camera heaters off and MCU heater off) 3.3A (stable @ 24V) / 6.6A (stable @ 12V) (with cameras, camera heaters on and MCU heater on)
Power Consumption	MDR-504 Variants: 7.2W (without cameras, camera heaters off and MCU heater off) 12W (with cameras, camera heaters off and MCU heater off) 60W (with cameras, camera heaters on and MCU heater on) MDR-508 Variants: 24W (with cameras, camera heaters off and MCU heater off) 79.2W (with cameras, camera heaters on and MCU heater on)
Trigger Inputs	8x (approx. 9.0V threshold input voltage)
12V Out Wire	1x 12V @ 3A Maximum Load 36V Short-to-rail protection, Short-to-GND protection
Trigger Outputs	2x 12V at 250mA Maximum Load 36V Short-to-rail protection, Short-to-GND protection
Video Input/output	1.0 Vp-p / 75Ω
Maximum Camera Supply Current	500mA
Power-up Time to Recording	50 Seconds

Test and Environmental Specification

Operating Temperature Range	CMR HDD: -40°C to +50°C SSD: -40°C to +70°C (Use built-in heater if temperature below 0°C)
Storage Temperature Range	-40°C to +85°C
Vibration Rating (Peak Acceleration in g and Test Standard)	CMR HDD: 1.5G SSD: 3.1G
Shock Rating (Peak Acceleration in g and Test Standard)	51G
Ingress Protection	IP30
Operating Relative Humidity	10% to 90%

Approvals

CE
UKCA
UNECE Regulation No. 10 Revision 5 (“E-marking”)
FCC
IC

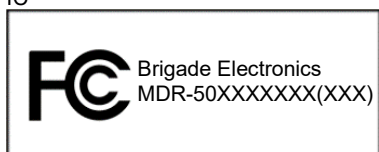

This device complies with part 15 of the FCC Rules. Operation is subject to the following two conditions: (1) This device may not cause harmful interference, and (2) this device must accept any interference received, including interference that may cause undesired operation.

Any change or modifications not expressly approved by the responsible party responsible for compliance could void the user’s authority to operate the equipment.

FCC Caution: Any changes or modifications not expressly approved by the party responsible for compliance could void the user’s authority to operate this equipment. This device complies with Part 15 of the FCC Rules. Operation is subject to the following two conditions: (1) This device may not cause harmful interference, and (2) this device must accept any interference received, including interference that may cause undesired operation. For products available in the US and Canadian markets, only channels 1~11 are available. You cannot select other channels. This device and its antennas must not be co-located or operated in conjunction with any other antenna or transmitter except in accordance with FCC multi-transmitter product procedures. This device operates in the ~2.4GHz frequency range. It is restricted to indoor environments only.

This device complies with Industry Canada license-exempt RSS standard(s). Operation is subject to the following two conditions: (1) this device may not cause interference, and (2) this device must accept any interference, including interference that may cause undesired operation of the device. For products available in the US and Canadian markets, only channels 1~11 are available. You cannot select other channels. This device and its antennas must not be co-located or operated in conjunction with any other antenna or transmitter except in accordance with IC multi-transmitter product procedures. This device may automatically discontinue transmission if there is no information to transmit, or an operational failure. Note that this is not intended to prohibit the transmission of control or signalling information or the use of repetitive codes where required by the technology. To reduce potential for harmful interference to co-channel mobile satellite systems, this device operates in the 5150-5250 MHz band, and is for indoor use only.

20 EU Declaration of Conformity

Product Types:

Brigade Mobile Digital Recorder System MDR-504XX-X-XX-XXX(XX), MDR-508XX-X-XX-XXX(XX).

Manufacturer:

Brigade House, The Mills, Station Road, South Darenth, DA4 9BD, UK

This declaration of conformity is issued under the sole responsibility of Brigade Electronics.

Objects of the declaration:

Mobile Digital Recorder System with GPS, Wi-Fi and 4G connectivity, including accessories and cables.

The objects of the declaration described above are in conformity with the relevant Union harmonisation legislation:

Directive 2014/53/EU

Relevant Harmonised Standards:

4G

- EN 301 489-1, EN 301-489-19 and EN 301-489-52.
- EN 301 908-1; EN 301 908-2; EN 301 908-13 and EN 301 511.
- EN 303 413.

Wi-Fi

- EN 301 489-1 and EN 301 489-17.
- EN 300 328.

GPS

- EN 301 489-1 and EN 301 489-19.
- EN 303 413.

Additional information:

4G

- Operational Frequency Band: LTE: B1,B3,B7,B8,B20,B28A; WCDMA: B1,B8; GSM: 900/1800MHz
- Maximum Transmitted Power: 35 dBm EIRP

Wi-Fi

- Operational Frequency Band: 2412 - 2472 MHz
- Maximum Transmitted Power: 15.82 dBm EIRP

The above equipment should be installed and operated with a minimum distance of 20cm between the mobile digital recorder and any human body.

Signed for and on behalf of Brigade Electronics Group PLC

South Darenth, DA4 9BD, UK

Thomas Schmidt

Thomas Schmidt

Group Quality Manager

21 Glossary

- 3G** – Third Generation
4G – Fourth Generation
AC – Adaptor Cable
ADPCM – Adaptive Differential Pulse-code Modulation
Alarms – An “EVENT” that has been configured (in the MDR unit settings) to be an alarm. Alarms are identified as orange video channel data on the playback timeline. These are displayed in the real-time alarm log in the MDR-Dashboard and MDR Mobile Apps. Alarms can generate email alerts and trigger automatic downloads (dependant on MDR-Dashboard configuration).
AHD – Analog High Definition
Automatic Download – A download that is set up in the MDR-Dashboard to automatically download data related to an occurring “Alarm” or “Event” between user-defined times. Configured under Download in MDR-Dashboard.
APN – Access Point Name
AVI – Audio Video Interleaved
BD – Blind Detection
CBR – Constant Bit Rate
CE – Conformité Européenne
CH – Channel
CHAP – Challenge Handshake Authentication Protocol
CIF – Common Intermediate Format (¼ D1 format)
CPU – Central Processing Unit
CRL - Certificate Revocation List
CU – Control Unit
D1 – D1 is full standard resolution for 25FPS (PAL) and 30FPS (NTSC)
DS – Docking Station
DST – Daylight Saving Time
EDGE – Enhanced Data GSM Environment
EIA – Electronic Industries Alliance
Events – An activation of an input e.g. Sensor input (trigger 1-8), G Sensor, Over speed etc. Events are identified as red vertical lines on the playback timeline. These are not shown in the real-time alarm log.
EXP – Expansion
FCC – Federal Communications Commission
FPB – Fireproof box
GB – Gigabyte
GHz – Gigahertz
GND – Ground
GPIO – General Purpose Input/output
GPRS – General Packet Radio Service
GPS – Global Positioning System
GSC – G-sensor Cable
G-Sensor - measure of acceleration/shock of the vehicle
GSM – Global System for Mobile Communications
GUI - Graphical user interfaces
H.264 – Video compression standard
HD1 – Half Definition compared to Full Definition (See D1)
HD – High Definition
HDD – Hard Disk Drive
HTTP - HyperText Transfer Protocol
HTTPS - HyperText Transfer Protocol Secure
HSDPA – High Speed Downlink Packet Access
HSPA – High Speed Packet Access
HSUPA – High Speed Uplink Packet Access
IC – Industry Canada
ID – Identification
IO – Input/output
iOS – i Operating System
IP – Internet Protocol
IR – Infra-red
IT – Information technology
Km/h – Kilometres per hour
LAN – Local Area Network
LED – Light Emitting Diode
MAC – Media Access Control
MB – Megabyte
MCU – Mobile Caddy Unit
MD – Motion Detection
MDR – Mobile Digital Recorder
MHz – Megahertz
MPH – Miles per hour
NET – Network
NTSC – National Television System Committee
OSD – On-screen Display
PAL – Phase Alternating Line
PAP – Password Authentication Protocol
PC – Personal Computer
PN – Part Number
PTZ – Pan, Tilt and Zoom
PWR – Power
REC – Record
RES – Resolution
RP – Remote Panel
RPC – Remote Panel Cable
S/N – Serial Number
Scheduled Download – A download that is manually setup from in the MDR-Dashboard (to be downloaded when the selected MDR connects to the server). Configured under Server in MDR-Dashboard.
SD – Secure Digital
SIM – Subscriber Identity Module
SMTP – Simple Mail Transfer Protocol
SPD – Speed
SQL – Structured Query Language
SSL – Secure Sockets Layer
TB – Terabyte
TIA – Telecommunications Industry Association
TLS - Transport Layer Security
TRIG – Trigger
UNECE – United Nations Economic Commission for Europe
USB – Universal Serial Bus
V – Voltage
VBR – Variable Bit Rate
VGA – Video Graphics Array
VIC – Video Input Cable
VL – Video Loss
VOC – Video Output Cable
W – Watt, standard unit of power
WCDMA – Wide Code Division Multiple Access
Wi-Fi – Wireless Fidelity
WEP – Wired Equivalent Privacy
WPA – Wi-Fi Protected Access
WPA2 – Wi-Fi Protected Access II

22 Disclaimer

Mobile digital recorder systems are an invaluable driver aid but do not exempt the driver from taking every normal precaution when conducting a manoeuvre. No liability arising out of the use or failure of the product can in any way be attached to Brigade or to the distributor.

Dénégation

Les enregistreurs numériques portables sont une aide précieuse pour le conducteur, mais celui-ci doit toutefois prendre toutes les précautions nécessaires pendant les manœuvres. Brigade ou ses distributeurs n'assument aucune responsabilité résultant de l'utilisation ou d'un défaut du produit.

Haftungsausschluss

Mobile Datenaufzeichnung Systeme sind für den Fahrer eine unschätzbare Hilfe, ersetzen aber beim Manövrieren keinesfalls die üblichen Vorsichtsmaßnahmen. Für Schäden aufgrund der Verwendung oder eines Defekts dieses Produkts übernehmen Brigade oder der Vertriebshändler keinerlei Haftung.

Condizioni di Utilizzo

I sistemi di registrazione digitale mobile costituiscono un prezioso ausilio alla guida, ma il conducente deve comunque assicurarsi di prendere tutte le normali precauzioni quando esegue una manovra. Né Brigade né il suo distributore saranno responsabili per eventuali danni di qualsiasi natura causati dall'utilizzo o dal mancato utilizzo del prodotto.

Aviso legal

Sistemas móviles grabadora digital son una ayuda inestimable driver pero no exime al conductor de tomar todas las precauciones normales al realizar una maniobra. Ninguna responsabilidad que surja del uso o fallo del producto puede de alguna manera acoplarse a la brigada o al distribuidor.

Declinação de responsabilidade

Celular gravador digital de sistemas são uma inestimável driver de auxílio, mas não isentam o driver de tomar todas normal precaução ao realizar uma manobra. Nenhuma responsabilidade decorrente da utilização ou falha do produto pode de qualquer maneira ser anexado ao de bombeiros ou para o distribuidor.

Specifications subject to change. Sous réserve de modifications techniques. Änderungen der technischen Daten vorbehalten. Specifiche soggette a variazioni. Las especificaciones están sujetas a cambios. Wijzigingen in specificaties voorbehouden. As especificações estão sujeitas a alterações. Спецификация может изменяться. Brigade Electronics belirttiği özellikleri haber vermeksizin istediği zaman değiştirebilir. Specyfikacja techniczna może ulec zmianie.

Verwerping

Mobiele digitale recorder systemen zijn een waardevolle hulp voor de bestuurder, maar stelt de bestuurder niet vrij van de normale voorzorgsmaatregelen bij het uitvoeren van een manoeuvre. Geen aansprakelijkheid voortvloeiend uit het gebruik of falen van het product kan op één of andere manier aan Brigade of aan de distributeur worden toegekend.

Отказ от обязательств

Системы видеорегистрации оказывают водителю неоценимую помощь при маневрировании, но не освобождают его от обязанности соблюдения обычных мер предосторожности. В ином случае компания Brigade или дистрибьютор не несет ответственность, возникающую в ходе использования или по причине неисправности данного продукта.

Hatırlatma

Mobil Sayısal Kayıt Cihazları sürücünün önemli bir yardımcısı olmakla birlikte, manevra esnasında sürücü bir kaza olmaması için her türlü önlemi almalıdır. Brigade veya bölgesel dağıtıcıları yapılacak yanlış bir uygulama ve sonucunda oluşabilecek maddi ve/veya manevi kayıplardan sorumlu tutulamaz.

Uwaga

Systemy mobilnych cyfrowych rejestratorów są niezastąpioną pomocą dla kierowcy, ale jego posiadanie nie zwalnia kierowcy z zachowania szczególnej ostrożności podczas manewrów. Żadna kolizja drogowa ani jej skutki nie mogą obciążać producenta urządzenia oraz jego dystrybutorów.

